



KILO®

KILO5K™ 7x25 mm LASER RANGEFINDER
WITH BALLISTIC DATA XCHANGE™

APPLIED BALLISTICS
THE SCIENCE OF ACCURACY 

 Bluetooth®

OPERATOR'S MANUAL

SIG SAUER®



TABLE OF CONTENTS

Introduction	3
Contents:	4
Key Features:	4
Product Identification	6
General Operation.	10
Attaching The Lanyard	23
Display Information	25
Changing Modes Of Operation	26
Programming Sequence.	27
BaseMap™	45
Frequently Asked Questions (FAQ):	46
Specifications	50
SIG SAUER® Electro-Optics Infinite Guarantee®/Limited Lifetime Warranty	58

Please visit sigsauer.com for Operator's Manual downloads, or download to your Smart device with the SIG BDx App.



INTRODUCTION

Congratulations on the purchase of your SIG SAUER® Laser Rangefinder. Your KILO5K™ is one of the most compact, advanced and simple to use rangefinders on the market. All of SIG SAUER'S rangefinders feature the fastest digital signal processing engine while streamlining the user interface for a no hassle, out of box experience.

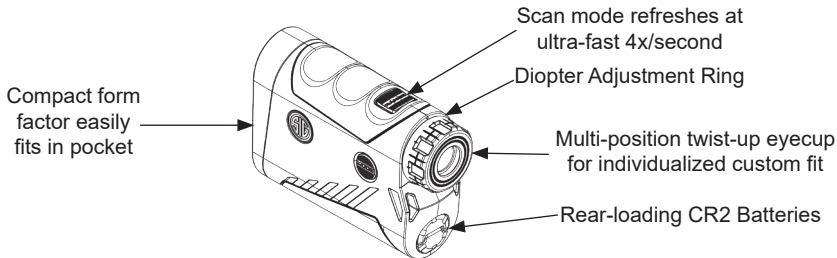



CONTENTS:

- KILO5K™ Rangefinding Binocular
- CR2 Battery (1)
- Premium Carry Pouch
- Quick Start Guide
- Ballistic Group Card
- Lanyard

KEY FEATURES:

- SIG SAUER'S Patent Pending Ballistic Data Xchange™ Technology utilizes, low energy Bluetooth with embedded Applied Ballistics Ultralight BDX-U, supports Applied Ballistics External BDX-X and works with the free BDX™ App to sync custom gun profiles and environmental conditions to your KILO® and pair your KILO to any BDX enabled riflescope. BDX-U provides ballistic solutions out to 800 meters while BDX-X supports any distance and works with external devices with AB Elite.
- 7x25 mm monocular with SpectraCoat™ anti-reflection coatings for superior light transmission and optical clarity.

- Revolutionary Gen II Lightwave™ DSP Technology for the fastest and longest distance rangefinder engine.
- HyperScan provides 4 range updates per second in scan mode while RangeLock reports the last range result when ranging distant targets.
- Features Line of Sight, Angle Modified Range, Extended Range (XR), and Fog mode along with First, Best, and Last Target Modes of operation.
- Projected, segmented transparent OLED display for daytime and low light use.
- Lumatic™ Display automatically calibrates display brightness to changing ambient light conditions.
- Compact, aluminum housing and eyecup with integral diopter adjustment.
- Simplified user interface with RANGE and MODE buttons only.
- Rangefinder configuration can now be done through the free SIG BDX™ App.
- Displays windage and elevation within KILO HUD for every target that is scanned.
- BDX 2.0® with 8 onboard, embedded ballistic groups along with QuickBOND® to bond your KILO with a BDX enabled sight or riflescope without having to use the BDX App.



PRODUCT IDENTIFICATION

- A. Power / Range Button
- B. Eyecup / Diopter Focus Adjustment
- C. Mode Button
- D. Lanyard Attachment Point
- E. Battery Compartment

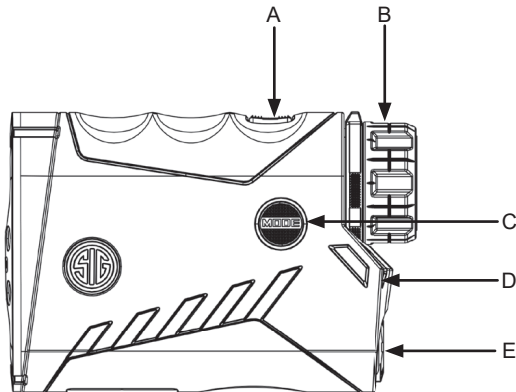

GEN II LIGHTWAVE™ DSP TECHNOLOGY

SIG SAUER'S proprietary Gen II Lightwave DSP engine leverages HyperScan – an advanced power management technique that provides the fastest refresh rate in scan mode (4 times per second) even at distances over 2 miles. Our DSP engine uses the latest generation field programmable gate array (FPGA) running sophisticated signal processing algorithms to reduce false positives while finding weak or distant targets.

RANGING ACCURACY, RESOLUTION AND MAXIMUM RANGES

The KILO5K™ provides line of sight or angle modified range information accurate to ± 1 yard or meter out to 500 yards; ± 2 yards from 500 - 3000 yards. Range is displayed in 0.1 yard or meter resolution.

RANGING PERFORMANCE IN HYPERSCAN MODE			
	Reflective	Trees	Deer
KILO5K™	Up to 5,000 yds	Up to 2,500 yds	Up to 2,000 yds



SIG SAUER BALLISTIC DATA XCHANGE 2.0 (BDX 2.0)

SIG SAUER'S Patent Pending BDX system takes the guesswork out of determining the proper range and ballistics solution for hitting your target with the first round. Low Energy Bluetooth combined with an embedded ballistic calculator (Applied Ballistics Ultralight) allows the user to configure up to 25, custom bullet profiles on the free BDX App and sync to your KILO®. Line of sight range, elevation and wind hold information is calculated instantly and displayed based on the active profile. When combined with one of SIG SAUER'S BDX enabled riflescopes, the user ranges a target and the firing solution is instantly shared with the BDX riflescope where the holdover dot is selectively illuminated.

BDX 2.0 has several new features for customers that want to get up and running without using the BDX smartphone App. Your KILO has 8 embedded ballistic groups. The first 6 groups are for centerfire rifles. Group 1 is the flattest shooting group with the least amount of drop. As the group numbers increase, so does the bullet drop. Using the included Ballistic Groups card, locate your caliber from the provided list. If your rounds are impacting low then move to a higher numbered group. If your rounds are impacting high then move to a lower numbered group. Group 7 represents common muzzleloaders and Group 8 represents an average crossbow. You can access these ballistic groups through the normal rangefinder configuration process by turning on the KILO and holding down the MODE button to enter programming mode.

QuickBOND™ allows you to quickly bond your KILO® to a SIERRA™ riflescope. On the SIERRA riflescope, insert the batteries and turn on to illumination setting 1. Then turn on the KILO by pressing and releasing the RANGE button. Press and hold down both the RANGE and MODE buttons for at least three seconds while looking through the KILO at the display. Once the display in the rangefinder reads “BOND” then “GOOD” your devices have been bonded (blue LED on the SIERRA should now be solid blue). Your calculated ballistic hold for any of the 8 ballistic groups or for a custom gun profile are now actively synced to your SIERRA riflescope.



GENERAL OPERATION

Your rangefinder provides 5 modes of operation: AMR, LOS, Archery, BDX-U (AB Ultralight), and BDX-X. AMR and LOS will be explained in the next section. When BDX-U is selected the user can pair the KILO® with a nearby smartphone where the BDX App should already be installed. The user configures a bullet profile in the app, which is actively synced with a paired rangefinder. For example, the user downloads and installs the BDX App, selects a 0.308 caliber bullet and chooses a Barnes LRXBT 200 gr bullet – this profile is selected and saved in real-time. The user will then configure the muzzle velocity, zero range, temperature and altitude within the BDX App.

Applied Ballistics External (BDX-X) allows the KILO to be paired with an external Kestrel Elite or Garmin Foretrex for more precise ballistic solutions beyond 800 meters. AB Elite includes support for Coriolis, spin drift and other factors while providing custom drag curves for the most accurate ballistic solutions in the industry.

MODES OF OPERATION - ANGLE MODIFIED RANGE (AMR) AND LINE OF SIGHT (LOS)

Angle modified range is the equivalent horizontal range to the target and is comparable to the “horizontal leg” of a triangle. AMR is also known as “rifleman’s rule” and uses the LOS range and angle of incline to calculate the horizontal distance the projectile travels between shooter and target. AMR is very accurate for shorter distances (i.e. < 400 yards).

Line of sight is the range to the target independent of angle. It is comparable to the “hypotenuse” of a triangle. When ranging in LOS mode, the distance is displayed in addition to the angle of incline. This method is preferred for those long range shooters and hunters wanting to use the LOS range and angle of incline to calculate a very precise holdover using a ballistic calculator smartphone application and/or wind measurement device.

For example, if the rangefinder is in LOS mode the line of sight range of 500 yards would be displayed along with the angle of -30 (degrees decline). Use LOS in combination with a ballistic calculator to calculate an exact holdover in minutes of angle or milliradians.

If the rangefinder is in AMR mode the angle modified range of 433.0 yards would be displayed. This is the equivalent horizontal range and can be used in combination with a ballistic / holdover reticle or with the SIG Ballistic Turret SBT™ dial.



ANGLE MODIFIED RANGE

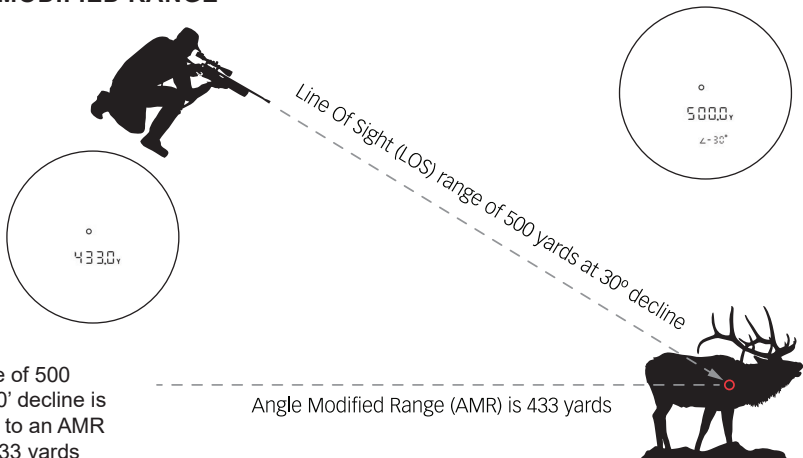

Example:

LOS range of 500 yards at 30° decline is equivalent to an AMR range of 433 yards

ARCHERY MODE

Archery mode is used to compensate for shooting arrows at extreme up/down angles. It requires knowing the speed of your arrow which is entered into the rangefinder in FPS. The rangefinder will produce a solution as an equivalent flat range shoot to distance. Due to the physical limitations of an arrow's range, after 200 yards the AMR distance to the target will be returned.

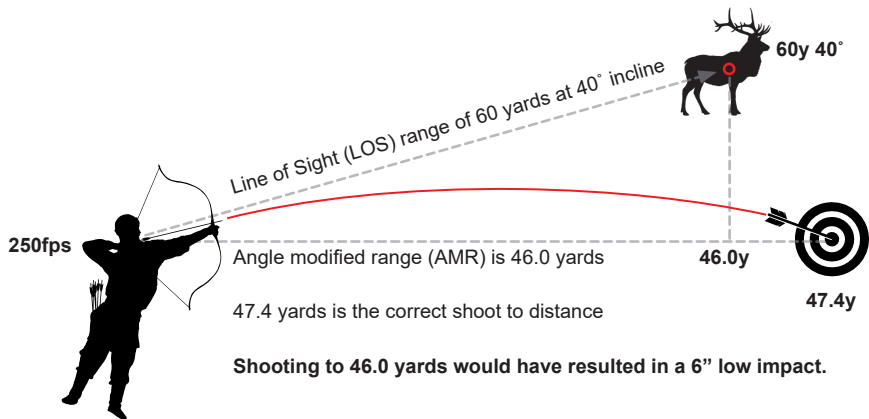

APPLIED BALLISTICS ULTRALIGHT (BDX-U) AND EXTERNAL (BDX-X)

Your rangefinder has an embedded ballistics solver developed by SIG SAUER, Applied Ballistics and nVisti. By pairing your KILO® with the free BDX App you can enter custom ballistics information for up to 25 bullet profiles and sync one at a time to your KILO. The active ballistic profile is now saved on your KILO, and when in BDX-U mode, will provide an accurate ballistic solution out to 800 meters maximum. The LOS range and angle of incline will be displayed for 2 seconds, then the elevation holdover value and finally the windage hold. This range and holdover information will continue to be displayed for 30 seconds or longer depending upon the time-out setting in the BDX App.

Wind direction and wind speed can also be configured within the App. The smartphone will actively sync all inputs with the KILO and the KILO can then be used without a smartphone. BDX provides a firing solution out to a maximum of 800 meters. Custom drag curves are not provided within the BDX App. For users that require more precision or will be shooting further than 800 meters, the KILO5K™ paired with an Applied Ballistics Elite device, such as a compatible Kestrel or Garmin product, is the preferred solution. When in BDX-U or BDX-X mode, paired and bonded with a BDX enabled sight, the Bluetooth icon will be visible and will flash when a new ballistic solution is calculated – which confirms your BDX enabled sight, received the new holdover information.

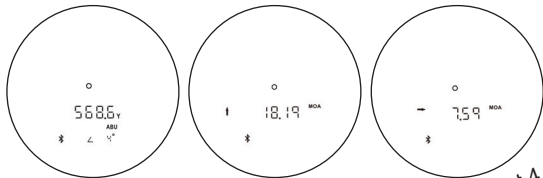

Line of Sight (LOS) range of 568.6 yards at 4 degrees incline



Example: LOS range = 568.6 yards with 0.308 Barnes
Elevation adjustment = 18.19 MOA Up
Windage adjustment = 7.59 MOA Right

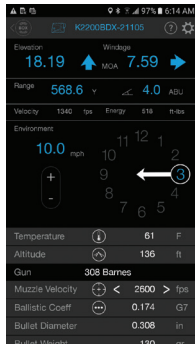

LUMATIC™ OLED DISPLAY

The KILO5K™ has the most advanced display on the market. Our transparent OLED display has the largest dynamic range providing for high brightness in bright sunlight or snow conditions, yet will dim down to near night vision levels at dusk and dawn. No other display offers this adaptive ability to prevent your pupil from constricting in low light causing you to no longer be able to see your target. A small, ambient light sensor (ALS) is located in the objective of the rangefinder and samples the ambient light condition of the target image. The ALS samples and updates the brightness instantaneously to always provide the right amount of contrast against your target image.



Display in Bright Light



Display in Low Light



PROJECTED, SEGMENTED ORGANIC LIGHT EMITTING DIODE (OLED) DISPLAY

- A. Circle Center Aiming Feature
- B. Elevation Hold and Wind Directional Indicator
- C. Target Mode (FIRST, BEST, LAST, XR, and FOG)
- D. Ranging Mode (AMR, LOS, BDX-U/X)
- E. Scope Connection
- F. 5 Character Alphanumeric Display
- G. Range Unit of Measure
- H. Holdover Unit of Measure
- I. Angle of Incline / Decline
- J. Battery Status Indicator

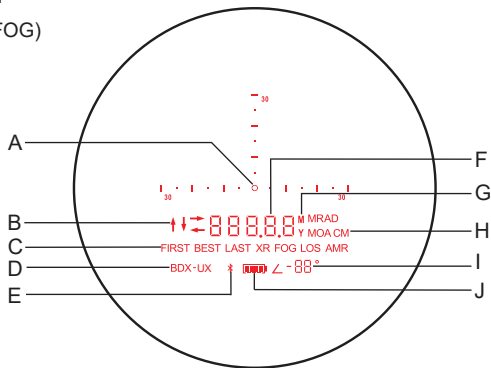

SAFETY AND OPERATION PROCEDURES

The KILO® is classified as a Class 3R product.



WARNING LASER



- **DO NOT PRESS THE RANGE BUTTON WHILE AIMING AT THE HUMAN EYE OR WHILE LOOKING INTO THE TRANSMITTING OPTICS ON THE OBJECTIVE SIDE.**
- **DO NOT LEAVE THE KILO WITHIN REACH OF SMALL CHILDREN.**
- **DO NOT TAKE THE PRODUCT APART OR MODIFY THE PRODUCT IN ANY WAY TO EXPOSE INTERNAL ELECTRONICS THAT MIGHT CAUSE DAMAGE OR ELECTRIC SHOCK.**
- **DO NOT USE ANY OTHER POWER SOURCE OTHER THAN A CR2 BATTERY OR EQUIVALENT.**



OPERATION

The KIL05K™ is designed to get you up and running without the typical complexity of buried menus and programming modes. The rangefinders come out of box in the following configuration and can also be configured with the free BDX App:

- A. Angle Modified Range (equivalent horizontal range)
- B. Best Target (rangefinder returns the best or most likely target, not the first or last)
- C. Illumination control (AUTO)
- D. Units of Measure in Yards

SET UP

Installing the Battery

Remove the battery cap by turning the cap in a counterclockwise direction. Insert (1) CR2 Primary Lithium battery (+) terminal side first. The (-) terminal should be facing out. Place the cap onto the (-) battery terminal and reinstall the battery cap by turning the cap in the clockwise direction.

CAUTION

BE CAREFUL TO NOT CROSS-THREAD THE CAP.

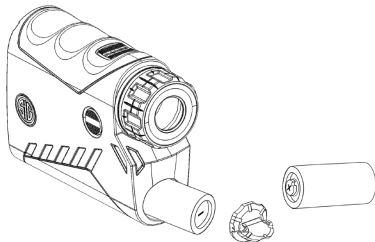



After installation of the battery and pressing the RANGE button, the status of the rangefinder is displayed:

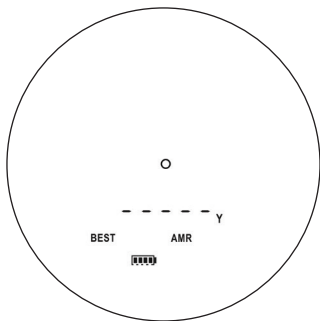

ATTACHING THE LANYARD

Install the lanyard loop through the lanyard attachment point. Pass the lanyard back through the loop for secure attachment.

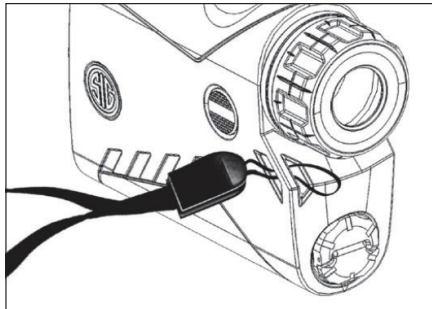



DIOPTER ADJUSTMENT

The diopter or focus adjustment is integral to the eyecup. The focus adjustment is used to bring the display into sharp focus along with the target image. The diopter adjustment can turn clockwise or counterclockwise depending upon the user's prescription.

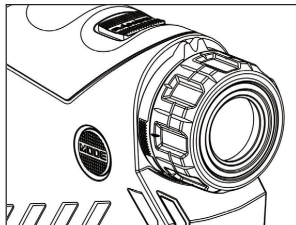

EYECUP ADJUSTMENT

The eyecup adjustment allows the user to adjust the eye relief for use with or without glasses. The eyecup rotates approximately 90 degrees counterclockwise allowing the user to adjust the eye relief by approximately 6 mm.

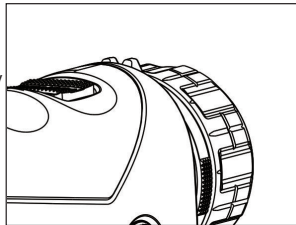

DISPLAY INFORMATION

The display shows you the center aiming circle, the unit of measure (Y), Angle Modified Range mode (AMR) and the remaining battery status. The display will remain active for up to 30 seconds, or whatever time-out has been set within in the SIG BDX App. You can then press the RANGE button to determine range to target.

If you press the RANGE button while the rangefinder is off and continue to hold the RANGE button down, the rangefinder will automatically switch into SCAN mode within 1 second.

After determining the distance to the target, the rangefinder will continue to display the center aiming circle and range data for 30 seconds – and only the range data. All other information is not shown after initial walk-up to prevent clutter in the field of view.

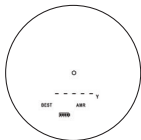

Display at initial wakeup

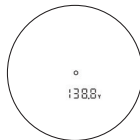

Display when ranging



HyperScan MODE

While the rangefinders support single button push ranging operation, it is highly recommended that you push and hold the RANGE button down to activate HyperScan mode. This mode allows you to scan targets at 4X/second which significantly improves ranging performance at extreme distances. As the ranging distances are updated very quickly in HyperScan mode, once you release the RANGE button the last acquired distance will be displayed. When ranging distant targets in HyperScan mode, the display may update between no result and a distant range. By using RangeLock technology the rangefinder will report the last range result when the RANGE button is released.

CHANGING MODES OF OPERATION

The rangefinder ships with the most common modes already configured. However, you can access and change the following features:

- Line of Sight (LOS), Angle Modified Range (AMR), Archery (Arch), AB Ultralight (BDX-U) or AB External (BDX-X)
- First, Best, Last Target, Extended Range (XR) or Fog
- Display Brightness (AUTO + 3 Low, 3 Medium and 3 High)
- Reticle Select (Center Circle, Horizontal Grid, or Horizontal and Vertical Grid)
- Units of Measure (Y or M)
- Ballistic Group Selection (Centerfire Groups 1-6, Muzzleloader Group 7 and Crossbow Group 8).
- Initiate QuickBOND (On or Off)

RANGEFINDER CONFIGURATION

PROGRAMMING SEQUENCE

Note – By using the free Sig BDX App you can easily program and configure your rangefinder.

1. Mode Selection (AMR, LOS, ARCH, BDX-U or BDX-X)

To enter programming mode, press and release the RANGE button to wake-up the rangefinder. Once the display is visible, press and hold the MODE button for 2 seconds – then release the MODE button and the current selection will be flashing (AMR is the default setting). You can switch between AMR, LOS, ARCH, BDX-U or BDX-X by pressing and releasing the RANGE button. Confirm your selection by pressing and releasing the MODE button which will save your setting and index to the next setting for configuration. If you do not press and release the MODE button the rangefinder will save your selection and turn off. If the user intends to use a calculated ballistic solution, the rangefinder must be in BDX-U or BDX-X mode. Instructions for downloading and configuring the BDX App on your smartphone will be detailed later in the instructions.



2. Target Selection (FIRST, BEST, LAST, XR or FOG)

FIRST, BEST, LAST, XR or FOG should be flashing. You can toggle between target modes by pressing and releasing the RANGE button. Confirm your selection by pressing and releasing the MODE button which will save your setting and index to the next setting for configuration. If you do not press and release the MODE button the rangefinder will save your selection and turn off. BEST Target can be used for most situations, however, when hunting through foliage or in high grass the LAST Target is recommended. XR mode can be used for extreme distances but the range result takes approximately 1 second to calculate. FOG mode can be used in misting or foggy environments.

3. Display Brightness

Display Brightness (Lumatic OLED Display) – AUTO will be used in most cases which leverages the ambient light sensor located in the objective of the rangefinder. This sensor samples the ambient light conditions and automatically adjusts the display to the local environment. You can change this to 9 individual settings: LOW 1 – 3, MED 1-3 and HI 1-3. Note – if you accidentally leave the unit on Setting LOW 1 you may not be able to see the display. If this occurs, go into a dark environment and change the illumination setting.

4. Unit of Measure Selection (Y or M)

Your current selection will be flashing (Yards is default). You can toggle between Y or M by pressing and releasing the RANGE button. Confirm your selection by pressing and releasing the MODE button which will save your setting and index to the next setting for configuration. If you do not press and release the MODE button the rangefinder will save your selection and turn off.

5. Ballistic Group Selection

Your current selection will be flashing (grP1 is default). You can toggle between a custom ballistic profile (APP) configured using the BDX App or one of the 8 ballistic groups by pressing and releasing the RANGE button. Confirm your selection by pressing and releasing the MODE button which will save your setting and index to the next setting for configuration. If you do not press and release the MODE button the rangefinder will save your selection and turn off. The programming sequence for selecting a custom ballistic profile or ballistic group is grP1 > grP2 > grP3 > grP4 > grP5 > grP6 > grP7 > grP8 > APP > grP1. If you have previously configured a custom ballistic profile then APP should be flashing. Your KILO® must be in BDX-U mode when using a custom bullet profile or any of the 8 embedded groups in order to display your holdover solution.



6. QuickBOND

The last selection is QuickBOND - bond will be flashing. You can turn ON or OFF QuickBOND by pressing and releasing the RANGE button. Confirm your selection by pressing and releasing the MODE button which will save your setting and return to ready to range. If you do not press and release the MODE button the rangefinder will save your selection and turn off. By toggling QuickBOND to the ON position, your KILO will automatically search for and bond to a nearby SIERRA™ riflescope set to illumination setting 1.

BALLISTICS DATA XCHANGE – DOWNLOADING AND CONFIGURING THE FREE BDx APP

In this section you will download the BDx App, pair the App with your KILO® and create a custom bullet profile.

1. Turn Bluetooth on

Check in Settings on your Android or iOS device to make sure that Bluetooth is on. If Bluetooth is off, switch it on.

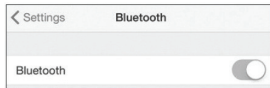
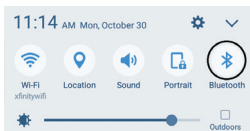
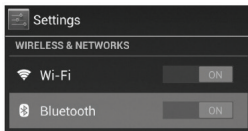



2. Download the BDX® App from the App Store / Google Play Store

Go to the App Store or the Google Play store and download the SIG SAUER BDX App. Search for the word SIG SAUER or BDX.



3. Launch the free SIG SAUER BDX® App and Pair with your KILO® (Enter your PIN code)

On your smartphone, open the BDX App, click on PAIRING, turn on your KILO by pressing and releasing the RANGE button and then press “Scan for Devices” on the App. Your rangefinder should be listed below the KILO icon and “Select Device”. Your rangefinder ID should be listed in white letters. Touch the ID in white. (Continued on next page)

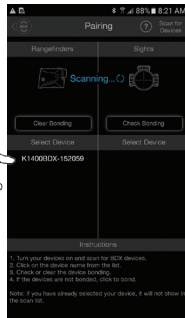
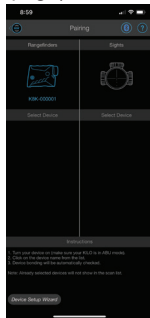
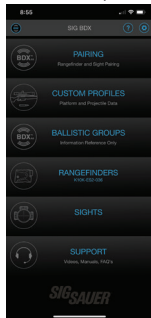



Make sure your KILO® stays on during the pairing process by periodically pressing and releasing the RANGE button. You will be prompted to look through your KILO for a PIN number. Type this PIN number into the open dialogue box within the App. The PIN in your KILO and the PIN entered on your smartphone must match. Press OK to complete the pairing operation. You will now see your KILO ID in blue listed below the KILO icon. You can now exit this screen. If you enter the incorrect PIN code you can restart this process over again. If you encounter any problems during this process close your App and let the KILO time out; restart the process over.

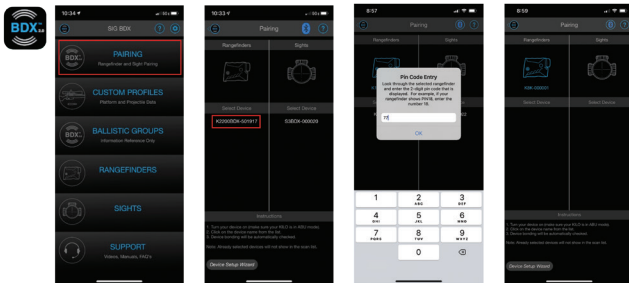

3a. Updating your KILO[®] to the latest software during Pairing

You may be prompted to update the software on your KILO. These software updates are mandatory and allow SIG SAUER to ensure that your BDX[®] App and KILO perform optimally. Most updates take less than 1 minute. Ensure that your KILO is turned on and that your smartphone has at least 25% battery life remaining before installing any software updates. For best operation be sure to keep your smartphone awake during the entire installation process.

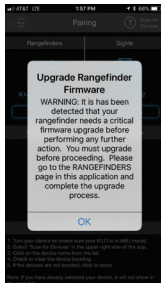
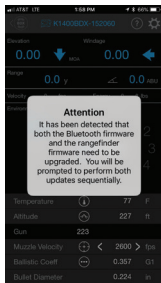



4. Configure up to 25 custom bullet profiles

The BDX® App allows you to create and modify up to 25 profiles. From the home screen of the App touch PROFILES. Only one profile can be active at any time and is denoted by the BDX Icon in blue to the right of the screen. The BDX App comes with one default 0.308 profile. You can edit this profile by touching “Profile 1” or create a new one by touching the “New Profile” in the upper right corner of the App. Next, touch LIBRARY then select a caliber and bullet manufacturer. On the Gun Profiles page you can rename the profile by touching on the “Custom Gun 1” and typing in a new name.

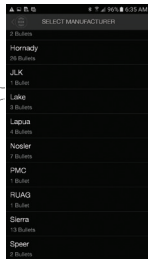
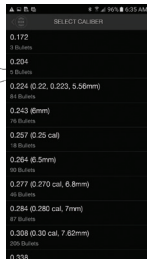
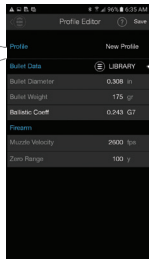
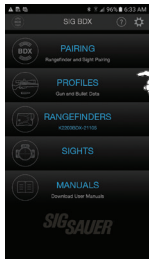

After selecting a bullet manufacturer, select the actual bullet you intend to use. Once selected you will return to the Gun Profile page where you will need to click on the sync icon to the right to activate this profile. In this example the new profile is called “.223 Sierra” – be sure to activate this profile.

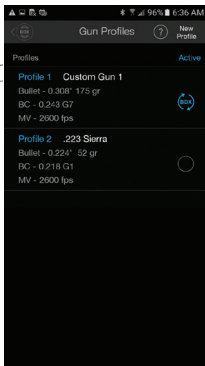
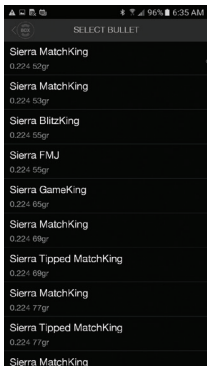



RANGEFINDER HEADS-UP DISPLAY (HUD)

From the home screen of your BDX® App select RANGEFINDERS to display the HUD. The HUD displays all range, environmental and ballistic information and allows you to configure your KILO®.

KILO ID and Status

Grey = disconnected / Blue = connected

- Back to Home Screen
- Elevation data
- Range to target and unit of measure
- Bullet velocity at target range
- Wind speed
- Ambient temperature
- Active gun profile
- Ballistic coefficient
- Bullet weight

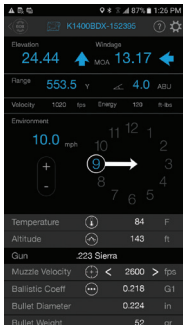

- Help and Settings menu
- Windage data
- Angle of include and Mode of Operation
- Bullet energy at target range
- Wind direction
- Local altitude
- Muzzle velocity and MV Calibration
- Bullet diameter

KILO® SETTINGS

From the Settings menu you can fully configure the following:

1. Rangefinder Mode (AMR, LOS, ARCH, BDX-U, BDX-X)
2. Target Mode (FIRST, BEST, LAST, XR, FOG)
3. Brightness (AUTO or 1 – 9 manual)
4. Range Units (Yards or Meters)
5. Sleep Time (30, 60, 120 or 180 seconds)
6. Sight Units (MOA or MRAD)
7. Battery Saver (On or Off)

You can toggle all fields by simply touching the letters in white. Your KILO must be turned on and paired. To save your settings touch the BDX icon in the upper left corner of the display. This will save your settings. You can also access the help menu by clicking on the “?” icon in the upper right of the screen.

Note – The KILO will not range when the Settings menu is open and active.

Note – The rangefinder must be in BDX-U or BDX-X mode to calculate real time ballistic solutions and send them to the SIG BDX Rifle scope with Bluetooth.

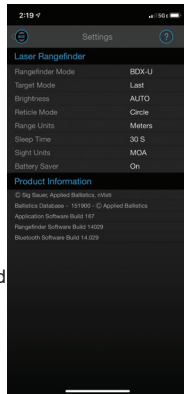



TEMPERATURE AND ALTITUDE

Your KILO® has onboard environmental sensors and when calculating ballistic solutions will by default use the onboard sensors. However, you can manually override the onboard sensors using the BDX App > RANGEFINDER page. The BDX App can pull temperature and altitude from the closest weather station. If you are not in cell phone range, you can manually update these values by touching on the white numbers in each field and manually updating these environmental conditions.

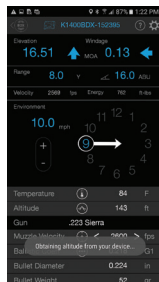
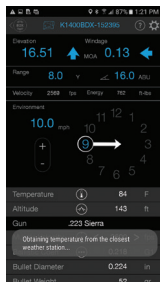
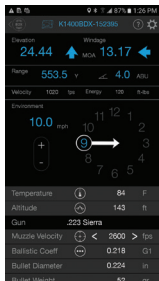

MUZZLE VELOCITY (MV) CALIBRATION

The most important input for calculating accurate Applied Ballistics solutions is getting your MV correct. You need to either chronograph your firearm or use the embedded MV Calibration routine built into the BDX® App. To use the MV Calibration routine make sure your scope is zeroed (i.e. at 100 yards) and verify that the BDX App is showing zero holdover values at the zero distance by ranging the target at the zero range and verifying that your holds are in fact zero

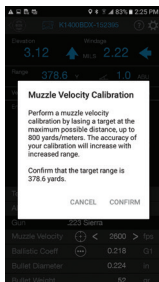
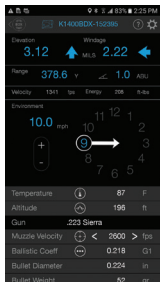

Use the MV Calibration routine at the farthest distance you intend to shoot. The greater the distance the more accurate the MV calculation will be. In this example the target was at 378 yards. Confirm your max target range.

Note – BDX-U only provides ballistic solutions out to 800 meters maximum.



MUZZLE VELOCITY (MV) CALIBRATION – (CONTINUED)

Now enter the elevation offset between point of impact and point of aim and select CONFIRM. In this example the 3 shot group was 7 inches low. A new MV of 2477 fps was calculated. Select YES to confirm and this MV will now be used for ballistic solutions going forward. See the confirmation dialogue box in the image below right.

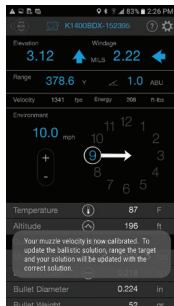
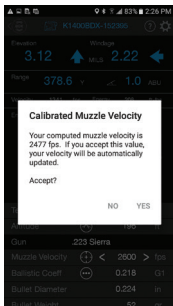
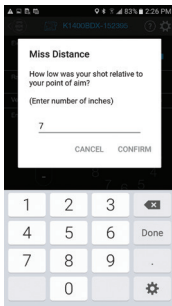

CONFIGURING GLOBAL SETTINGS IN THE BDX® APP

From the Home Screen of the BDX App you can configure Global Settings. Any field that is in white can be changed by touching on the unit of measure and toggling between values. The help menu is available to assist you. Global Settings include:

1. Range Units (yards, meters)
2. Wind Speed Units (mph, m/s, kph)
3. Muzzle Velocity Units (fps, m/s)
4. Bullet Diameter Units (inches, cm)
5. Bullet Weight Units (grains, grams)
6. Temperature Units (F, C)
7. Altitude Units (feet, meters)
8. Gun Parameters (inches, cm)
9. Clear Saved Devices List
10. Skip Device Setup
11. BDX Offers and More

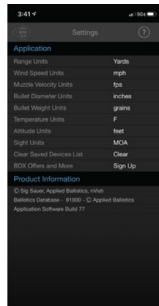
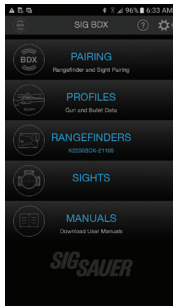



PAIRING A KESTREL® OR GARMIN® WITH AB ELITE

Using the RANGE / MODE buttons on your KIL0 or the BDX App, put the KIL0 in BDX-X (AB External) mode. This allows the KIL0 to be discoverable by the Kestrel or Garmin. BDX-X will be displayed in the KIL0. AB External will be displayed in the App. Close the BDX App.

Next, turn on your Kestrel. Follow the instructions for the Kestrel to turn on the Bluetooth radio and connect devices to the Kestrel (<https://kestrelinstruments.com/support/manuals-anddownloads>).

On the Kestrel, open the Options Menu and select BLUETOOTH, set BLUETOOTH ON. Next, set CONCT to DEVICE. Then, scroll down and select the KIL0 - the KIL0 must be turned on and in BDX-X mode. You should see K5K-12345 listed on the Kestrel. Select and exit the menu. Your Kestrel is now paired to your KIL0. Note - the BDX App will no longer work properly when a Kestrel is actively paired to the KIL0. However, if your KIL0 was previously paired and bonded with a SIERRA3 or other BDX enabled sight this link will be maintained. When actively paired with the Kestrel you will now be able to range targets and receive accurate ballistic holdover solutions displayed on the Kestrel and within the KIL0.

BASEMAP™

To connect your KILO to your BaseMap app, first, open BaseMap. Tap on Tools in the lower right. Tap on BaseMap Connect in the upper right. Turn on Bluetooth, if needed, and tap on your rangefinder in the available devices menu. Read the PIN in your rangefinder display and enter it in the BaseMap popup. Select OK. Your rangefinder is now paired with BaseMap. Use the Remote Marker option from the tools menu to range targets and automatically drop markers on your map at that location.

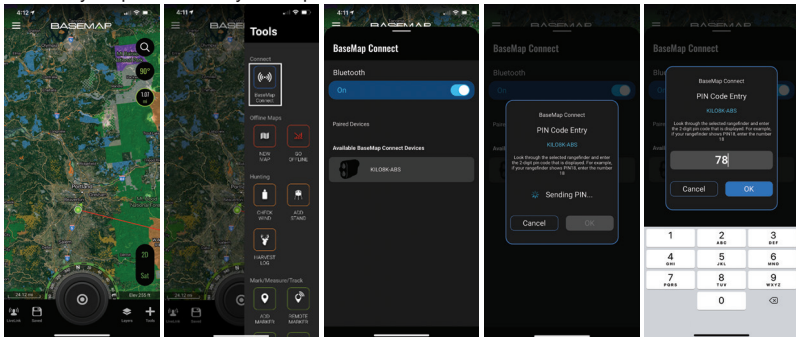



FREQUENTLY ASKED QUESTIONS (FAQ):

Q: I can't get the display to focus.

A: You need to adjust the diopter ring to your vision. Rotate the eyecup / diopter ring in either direction until the display comes into sharp focus.

Q: I can't seem to range very far past trees or animals.

A: Your KILO® will perform differently based on changes in ambient conditions such as bright sunlight or snow, rain or fog, temperature and the reflectivity of the target being ranged. For example, at dusk and dawn your rangefinder may be able to range trees at over 1000 yards but in bright sunlight may only achieve 500 yards. If your KILO will not range at least 400 yards under normal conditions (fog and rain excluded) please contact customer service. Your product may have fallen out of alignment.

Q: I can't get my KILO to pair with the BDX® App on my smartphone.

A: Delete the BDX App from your smartphone. Download and reinstall on your phone. Make sure you have a fresh battery in your KILO. Relaunch the App, turn on your KILO and repeat the Pairing instructions in this manual.

Q: I can't locate the BDX App on the Apple or Android Stores.

A: Search for SIG SAUER or BDX at the store.

Q: My battery drains too fast.

A: Most rangefinders will provide over 4000 individual range calculations using a fresh CR2 primary lithium battery. Your KILO® exceeds this specification. When heavily using SCAN mode the battery may appear to drain faster since your KILO is ranging 4x per second in HyperScan mode. This is normal operation but you should keep a spare CR2 battery when heading out to remote locations. Your KILO now features Battery Saver mode which can be enabled in the RANGEFINDER > SETTINGS page within the BDX App. This will limit your range results to 2,000 yards maximum but will double the runtime of your rangefinder.

Q: My ballistic solution in the HUD and displayed in the KILO is always off a few inches.

A: For accurate ballistic solutions make sure you have updated the temperature and altitude within the App to your current location, you have the correct bullet caliber (diameter) and weight selected, your zero distance is correct and that your muzzle velocity is correct. Using the MV Calibration routine provides the most accurate MV and will improve the accuracy of the ballistic calculator. It is always best to use the MV Calibration routine at the farthest distance you intend to shoot. Calibrating at 500 yards will yield a better MV than calibrating at 200 yards.

Q: My blue LED on the power selector ring on the SIERRA3™ will not turn on.

A: Look through our SIERRA3. You most likely have the Digital Ballistic Reticle turned on. Go into your BDX App, select the SIGHTS page and turn the Ballistic Reticle OFF.



Q: When using AB External on my KILO I can no longer see the rangefinder information on the HUD in the BDX App.

A: If your KILO and a Kestrel are actively paired (sending / receiving information) the BDX App cannot be connected and paired to your KILO at the same time.

Q: My KILO is set to AB External but isn't displaying holdover information.

A: To display a complete ballistic solution your KILO must be actively paired with a Kestrel. No holdover information is displayed unless the Kestrel and KILO are both on and actively paired.

Q: The rangefinder HUD in the BDX App is sluggish when using my KILO in AB External mode (Kestrel is not paired to the KILO)

A: AB External mode on your KILO was designed to be used directly with a Kestrel with AB Elite on board. This communications protocol is relatively slow and does not respond quickly as compared to using AB Ultralight. AB Ultralight resides on your KILO and is much faster for calculating ballistic solutions out to 800 meters.

Q: My KILO and Kestrel are paired but I am not getting anything but zero's for elevation and wind holds.

A: You need to setup at least one custom bullet profile on your Kestrel. See the Kestrel instructions for setting up a bullet profile.

THIS PAGE INTENTIONALLY LEFT BLANK

**KILO5K™
7x25 mm****SPECIFICATIONS**

Magnification	7x		
Objective Clear Aperture	25 mm		
Exit Pupil	3.6 mm		
Eye Relief	15 mm		
Angular (FOV)	6.78°		
FOV @ 100 yds	35.67 ft		
Laser Divergence	1.3 MRAD		
Range Response Time	.25 sec		
Scanning	Yes		
Range Resolution Under 100 yds	.1 yds		
Max Range	Reflective Up to 5,000 yds	Trees Up to 2,500 yds	Deer Up to 2,000 yds
Weight with Battery	7.5 oz / 215 g		

A – 3 in / 76 mm

B – 4.4 in / 112 mm

C – 1.3 in / 33 mm

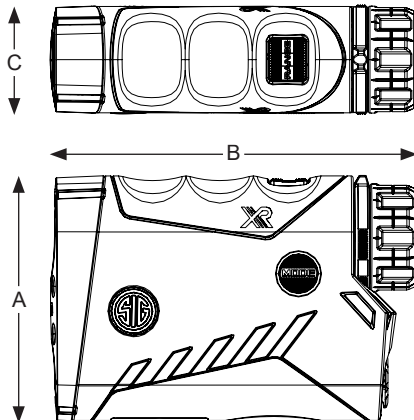



WARNING LASER



CLASS 3R LASER PRODUCT. INVISIBLE LASER RADIATION. DO NOT VIEW DIRECTLY WITH EYES OR OPTICAL INSTRUMENTS (BINOCULARS OR TELESCOPES)

Complies with FDA performance standards for laser products except for conformance with IEC 60825-1 Ed.3., as described in Laser Notice 56, dated May 8, 2019.

FCC ID: 2AP8SK5K IC: 24032-K5K
Pp < 23W, $\lambda = 905 \text{ nm}$, t = 22 ns



This product has been tested and found to comply with the limits for a Class B digital device, pursuant to Part 15 of the FCC Rules. The equipment generates, uses and can radiate radio frequency energy and, if not installed and used in accordance with these instructions, may cause harmful interference to radio communications. However, there is no guarantee that interference will not occur in a particular installation. If this product does cause interference to radio or television reception the user is encouraged to try to correct the interference by one or more of the following:

- Reorient or relocate the receiving antenna
- Increase the separation between this product and the receiver
- Connect the equipment to an alternative outlet or receiver
- Consult a technician.

Shielded interference cable must be used with the equipment in order to comply with the limits for a digital device pursuant to Subpart B of Part 15 of FCC Rules.

Specifications and designs are subject to change without any notice or obligation on the part of the manufacturer.

CAUTION

Use of controls or adjustments or performance of procedures other than those specified herein may result in hazardous radiation exposure. Changes or modifications not expressly approved by the party responsible for compliance could void the user's authority to operate the equipment.



LASER APERTURE



FCC STATEMENT:

This device complies with Part 15 of the FCC rules. Operation is subject to the following two conditions:

- This device may not cause harmful interference, and
- This device must accept any interference received, including interference that may cause undesired operation.

Changes or modifications not expressly approved by the party responsible for compliance could void your authority to operate the equipment.

NOTE

This equipment has been tested and found to comply with the limits for a Class B digital device, pursuant to Part 15 of the FCC Rules. These limits are designed to provide reasonable protection against harmful interference in a residential installation.

This equipment generates uses and can radiate radio frequency energy and, if not installed and used in accordance with the instructions, may cause harmful interference to radio communications. However, there is no guarantee that interference will not occur in a particular installation. If this equipment does cause harmful interference to radio or television reception, which can be determined by turning the equipment off and on, the user is encouraged to try to correct the interference by one or more of the following measures:

- Reorient or relocate the receiving antenna.
- Increase the separation between the equipment and receiver.
- Connect the equipment into an outlet on a circuit different from that to which the receiver is connected.
- Consult the dealer or an experienced radio/TV technician for help.



INDUSTRY CANADA:

This device complies with Industry Canada licence RSS standard(s). Operation is subject to the following two conditions:

- This device may not cause interference, and
- This device must accept any interference, including interference that may cause undesired operation of the device.

Le présent appareil est conforme aux CNR d'Industrie Canada applicable aux appareil radio exempts de licence.

L'exploitation est autorisée aux deux conditions suivantes:

- l'appareil ne doit pas produire de brouillage, et
- l'utilisateur de l'appareil doit accepter tout brouillage radio électrique subi, même si le brouillage est susceptible d'en compromettre le fonctionnement

The device meets the exemption from the routine evaluation limits in section 2.5 of RSS 102 and compliance with RSS-102 RF exposure, users can obtain Canadian information on RF exposure and compliance.



WARNING: CANCER AND REPRODUCTIVE HARM—www.P65warnings.ca.gov



SIG SAUER ELECTRO-OPTICS INFINITE GUARANTEE[®]/LIMITED LIFETIME WARRANTY

SIG SAUER has manufactured the most rugged, dependable, high-performance firearms for more than two centuries. Our heritage of design, engineering, and precision-manufactured quality predates the existence of any other optics company worldwide. We understand the importance of quality in the line of fire, at the shooting range or on your next hunt. SIG SAUER Electro-Optics had to earn the right to wear that badge and the Infinite Guarantee has your back, forever. Period.



We will repair or replace your SIG SAUER product in the event it becomes damaged or defective, at no charge to you. If we cannot repair your product, we will replace it with a product in perfect working order of equal or better physical condition.

SIG SAUER[®] Infinite Guarantee[®]

- Unlimited Lifetime Guarantee
- Fully Transferable
- No Warranty Card Required
- No Receipt Required
- No Time Limit Applies
- No Charge

Please note that our Infinite Guarantee excludes coverage for intentional damage, misuse, cosmetic damage that does not affect the performance of the optic, loss, theft, or unauthorized repair or modification. Excludes electronic and Tritium components.

Customers seeking warranty coverage must first obtain a Return Merchandise Authorization (RMA) by contacting SIG SAUER Customer Service, and return the product unloaded and freight prepaid.

ANY WARRANTIES IMPLIED BY LAW, INCLUDING ANY IMPLIED WARRANTIES OF MERCHANTABILITY OR FITNESS FOR A PARTICULAR PURPOSE, ARE EXPRESSLY DISCLAIMED. REPAIR, ALTERATION, OR REPLACEMENT AS PROVIDED HEREIN IS YOUR EXCLUSIVE REMEDY FOR ANY DEFECTIVE PRODUCT. IN NO EVENT SHALL SIG SAUER OR ANY COMPANY AFFILIATED WITH SIG SAUER BE LIABLE FOR ANY SPECIAL, INCIDENTAL, OR CONSEQUENTIAL DAMAGES OF ANY KIND ARISING OUT OF THE PURCHASE OR USE OF THIS PRODUCT, WHETHER BASED UPON CONTRACT, TORT, STATUTE, OR OTHERWISE. Some states do not allow the exclusion or limitation of implied warranties, or the exclusion or limitation of incidental or consequential damages, so some or all of the above limitations or exclusions may not apply to you. This warranty gives you specific legal rights, and you may also have other rights which vary from State to State.

THIS WARRANTY APPLIES TO COMMERCIAL CUSTOMERS ONLY, AND DOES NOT APPLY TO GOVERNMENT, MILITARY, LAW ENFORCEMENT, OR NON-US CUSTOMERS. NON-US COMMERCIAL CUSTOMERS MUST PURCHASE PRODUCT THROUGH AN AUTHORIZED SIG SAUER DEALER WITHIN THEIR COUNTRY OF RESIDENCE FOR THIS WARRANTY TO APPLY.



SIG SAUER® ELECTRONIC COMPONENT LIMITED 5-YEAR WARRANTY



SIG SAUER warrants that the electronic and tritium components of the enclosed product were originally manufactured free of defects in workmanship, material, and mechanical function. For a period of five (5) years from the date of manufacture, SIG SAUER agrees to correct any defect in these components by repair, adjustment, or replacement, at SIG SAUER'S option, with the same or comparable quality components (or by replacing the product at SIG SAUER'S option); provided however that a Return Merchandise Authorization (RMA) is first obtained by contacting SIG SAUER Customer Service, and that the product is returned unloaded and freight prepaid.

This limited warranty is null and void if the product has been misused, damaged (by accident or otherwise), damaged through failure to provide reasonable and necessary maintenance as described in the user's manual, or if unauthorized repair or any alteration, including of a cosmetic nature, has been performed on the product. This limited warranty does not apply to normal cosmetic wear and tear of any parts.

ANY WARRANTIES IMPLIED BY LAW, INCLUDING ANY IMPLIED WARRANTIES OF MERCHANTABILITY OR FITNESS FOR A PARTICULAR PURPOSE, ARE EXPRESSLY DISCLAIMED. REPAIR, ALTERATION, OR REPLACEMENT AS PROVIDED HEREIN IS YOUR EXCLUSIVE REMEDY FOR ANY DEFECTIVE PRODUCT. IN NO EVENT SHALL SIG SAUER OR ANY COMPANY AFFILIATED WITH SIG SAUER BE LIABLE FOR ANY SPECIAL, INCIDENTAL, OR CONSEQUENTIAL DAMAGES OF ANY KIND ARISING OUT OF THE PURCHASE OR USE OF THIS PRODUCT, WHETHER BASED UPON CONTRACT, TORT, STATUTE, OR OTHERWISE.

Some states do not allow the exclusion or limitation of implied warranties, or the exclusion or limitation of incidental or consequential damages, so some or all of the above limitations or exclusions may not apply to you. This warranty gives you specific legal rights, and you may also have other rights which vary from State to State.

THIS WARRANTY APPLIES TO COMMERCIAL CUSTOMERS ONLY, AND DOES NOT APPLY TO GOVERNMENT, MILITARY, LAW ENFORCEMENT, OR NON-US CUSTOMERS. NON-US COMMERCIAL CUSTOMERS MUST PURCHASE PRODUCT THROUGH AN AUTHORIZED SIG SAUER DEALER WITHIN THEIR COUNTRY OF RESIDENCE FOR THIS WARRANTY TO APPLY.



NOTES:

NOTES:

SIG SAUER®

sigsauer.com

FOR PRODUCT SERVICE ON THIS MODEL, PLEASE CALL 603-610-3000

27100 SW Parkway Avenue, Wilsonville, Oregon 97070 USA