



KILO®

KILO8K-ABS™ 7x25 mm LASER RANGEFINDER
WITH BALLISTIC DATA XCHANGE™

APPLIED BALLISTICS
THE SCIENCE OF ACCURACY 

 Bluetooth®

OPERATOR'S MANUAL

SIG SAUER®

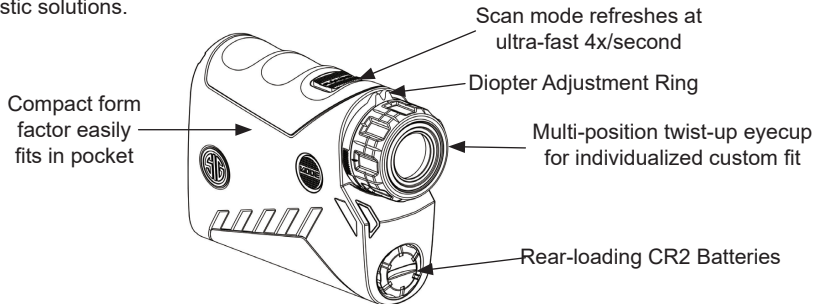

TABLE OF CONTENTS

Introduction	3
Contents	4
Key Features	5
Product Identification	7
General Operation	16
Installing / Using the BDX App	30
BaseMap™	55
Frequently Asked Questions (FAQ)	56
Specifications	62
Sig Sauer Electro-Optics Infinite Guarantee®/Limited Lifetime Warranty	70

INTRODUCTION

Congratulations on the purchase of your SIG SAUER® Laser Rangefinder. Your KILO features the new Gen II LightWave DSP engine, Applied Ballistics Elite and Ballistic Data Xchange™ (BDX). Improved range performance and the industry's first Active Matrix Organic Light Emitting Diode (AMOLED) display for sophisticated range and ballistic information presentation. Use your KILO for extreme distance ranging, remote waypoint tagging, compass navigation and precise ballistic solutions.





CONTENTS

- KILO Rangefinder
- CR2 Primary Lithium Battery (2)
- MultiCam Ballistic Nylon Pouch
- MultiCam Ballistic Nylon MOLLE Bag
- Lanyard
- CNC Billet Aluminum Tripod Adapter
- WeatherFlow BLE WINDMeter
- Owner's Manual

The most recent Operator's Manual can be downloaded from the SIG SAUER website and can also be accessed through the free BDX App.

KEY FEATURES

- 7 x 25 mm Monocular with SpectraCoat™ anti-reflection coatings for superior low-light transmission and optical clarity.
- SIG SAUER's Patent Pending Ballistic Data Xchange™ (BDX) technology for communicating with any BDX enabled sight over low energy Bluetooth®.
- Lumatic™ red AMOLED display adjusts automatically for changes in ambient light conditions and provides a full graphic display for real-time range and ballistic information.
- Low Energy Bluetooth® Long Range 5.x improves connectivity distance to Bluetooth enabled devices.
- Gen II Lightwave DSP Technology for the fastest, furthest and most accurate range results of any rangefinder available.
- Embedded Applied Ballistics Elite with bullet database and support for G1/G7 and AB Custom Drag curves; store up to 30 custom bullet profiles. Ballistic results are provided in either MOA or MRAD.
- Integration with BaseMap for remote waypoint tagging.
- HotKey Activation for rapid wind heading / wind speed input.
- QuickBOND for instantly bonding your KILO to any BDX enabled sight without the use of the BDX App.
- Onboard environmental sensors including temperature, pressure, humidity, inclinometer and digital compass.
- 4 Ranging Modes: Line of Sight (LOS), Angle Modified Range (AMR), Applied Ballistic Elite (BDX-U) and Applied Ballistic External (BDX-X)
- 5 Target Modes: FIRST, BEST, LAST, Extended Range (XR) and Fog.



SAFETY AND OPERATION PROCEDURES

The KILO® is classified as a Class 3R product.



WARNING

- **DO NOT PRESS THE RANGE BUTTON WHILE AIMING AT THE HUMAN EYE OR WHILE LOOKING INTO THE TRANSMITTING OPTICS ON THE OBJECTIVE SIDE.**
- **DO NOT LEAVE THE KILO WITHIN REACH OF SMALL CHILDREN.**
- **DO NOT TAKE THE PRODUCT APART OR MODIFY THE PRODUCT IN ANY WAY TO EXPOSE INTERNAL ELECTRONICS THAT MIGHT CAUSE DAMAGE OR ELECTRIC SHOCK.**
- **DO NOT USE ANY OTHER POWER SOURCE OTHER THAN A CR2 BATTERY OR EQUIVALENT.**

PRODUCT IDENTIFICATION

- A. Power / Range Button
- B. Eyecup / Diopter Focus Adjustment
- C. Mode Button
- D. Lanyard Attachment Point
- E. Battery Compartment

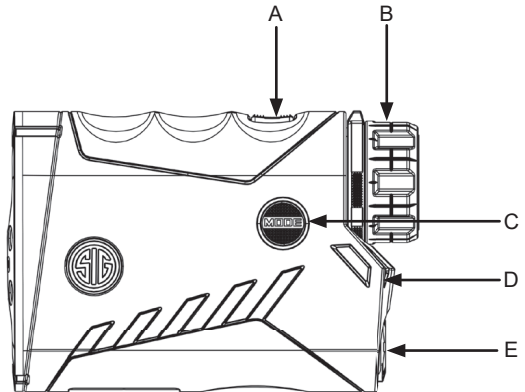



INITIAL SET UP

Installing the Battery

Remove the battery cap by turning the cap in a counterclockwise direction. Insert (1) CR2 Primary Lithium battery (+) terminal side first. The (-) terminal should be facing out. Place the cap onto the (-) battery terminal and reinstall the battery cap by turning the cap in the clockwise direction.

CAUTION

BE CAREFUL TO NOT CROSS-THREAD THE CAP.

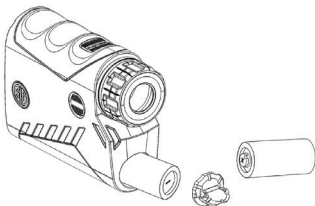

After installation of the battery and pressing the RANGE button, the startup screen and status of the rangefinder is displayed:

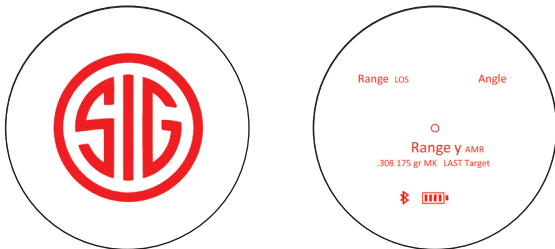

The startup screen with the SIG logo can be exited at any time by pressing the RANGE or MODE buttons. The startup screen can also be permanently deactivated using the MENU system on your KILO or using the BDX App in the RANGEFINDER > SETTINGS page.



INSTALLING THE LANYARD

Install the lanyard loop through the lanyard attachment point.
Pass the lanyard back through the loop for secure attachment.

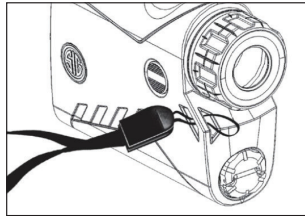

DIOPTER ADJUSTMENT

The diopter or focus adjustment is integral to the eyecup. The focus adjustment is used to bring the display into sharp focus along with the target image. The diopter adjustment can turn clockwise or counterclockwise depending upon the user's prescription.

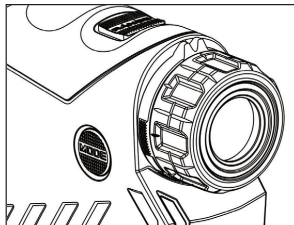

EYECUP ADJUSTMENT

The eyecup adjustment allows the user to adjust the eye relief for use with or without glasses. The eyecup rotates approximately 90 degrees counterclockwise allowing the user to adjust the eye relief by approximately 6 mm.

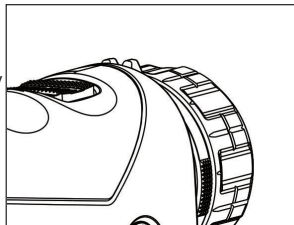



GEN II LIGHTWAVE™ DSP TECHNOLOGY

Your KILO features SIG SAUER's second generation rangefinder engine. The new rangefinder engine features the latest generation, low power Field Programmable Gate Array (FPGA), a new Bluetooth 5.x Microcontroller (MCU) and a state of the art Analog to Digital Converter (ADC) to detect remote targets, which dramatically increases the range performance and sensitivity in any environment. Environmental sensors are now embedded in each BDX enabled KILO along with the latest Applied Ballistics calculator. The new KILOs still feature HyperScan for fast range results at up to 4 times per second and now includes FIRST target identification, FOG mode and Extended Range (XR) mode for use in tripod mounted applications. XR mode increases the range samples by a factor of 4, which improves remote target detection at extreme distances and is best utilized when the rangefinder is tripod mounted. All KILOs are field upgradeable with the BDX App ensuring your KILO will always have the latest features.

There are now 5 Target Modes: FIRST, BEST, LAST, XR and FOG. Your KILO detects multiple potential range results for every button press. Using Digital Signal Processing (DSP), the best range results are stored for every range calculation. When in FIRST target mode – the first valid range result is displayed. When in LAST target mode – the last valid range result is displayed. When in BEST target mode – the strongest valid range result is displayed. When SCAN mode is used (press and hold the RANGE button) your rangefinder will keep a running summary of range results and when in FIRST target mode – the closest target will be displayed and persist being displayed.

When in LAST target mode the farthest of all target distances will be displayed. For example, if there are three targets at different distances, i.e. 100, 50 and 300 yards, as you scan across these targets in FIRST target mode you would see “100” then “50” and then “50” as you scan across all three targets. In LAST target mode “100”, “100” and then “300” would be displayed.

FOG mode leverages additional DSP algorithms to filter out false readings and will display the last valid target detected.

XR mode provides range results at one update per second (instead of 4 times per second). In this mode the sampling rate is 4 times larger and allows detection of distant targets, and will always display the last valid target when one is detected.

Your KILO has a maximum reflective range up to 8,000 yards or over 4.5 miles. Due to the longer sampling time, your rangefinder may consume your battery faster than legacy SIG SAUER products when in SCAN mode. There is a Battery Saver mode that can be enabled to restrict your maximum range to 2,000 yards which will at least double the runtime of your KILO. You can find this setting in the MENU on your KILO and on the BDX App on the RANGEFINDER > SETTINGS page.

Solar load conditions play a major factor in detecting remote targets; under high solar loads you may experience difficulty in detecting distant targets, however, in overcast or morning / evening conditions you will easily be able to detect targets at extreme distances.



SIG SAUER BALLISTIC DATA XCHANGE 2.0 (BDX 2.0)

SIG SAUER's Patent Pending BDX system takes the guesswork out of determining the proper range and ballistics solution for hitting your target with the first round. Low Energy Bluetooth combined with an embedded ballistic calculator (Applied Ballistics Elite) allows the user to configure up to 30, custom bullet profiles on the free BDX App and sync to your KILO. Line of sight range, elevation and wind hold information is calculated instantly and displayed based on the active profile. When combined with one of SIG SAUER's BDX enabled riflescopes, the user ranges a target and the firing solution is instantly shared with the BDX riflescope where the holdover dot is selectively illuminated.

QuickBOND™ allows you to quickly bond your KILO to any BDX enabled scope or sight. On a SIERRA riflescope, insert the batteries and turn on to illumination setting 1. Next, turn on the KILO by pressing and releasing the RANGE button. Press and hold down both the RANGE and MODE buttons for at least three seconds while looking through the KILO at the display. A menu will pop-up giving you the option of setting wind speed and heading, or to initiate QuickBOND. Using the MODE button index down to QuickBOND and press the RANGE button. Once the display in the rangefinder reads "BOND" then "GOOD" your devices have been bonded (blue LED on the SIERRA should now be solid blue). Your calculated ballistic hold for any ballistic solution is now actively synced to your SIERRA riflescope.

ACTIVE MATRIX ORGANIC LIGHT EMITTING DIODE DISPLAY (AMOLED)

Your KILO features an industry first, 304 x 256 pixel red AMOLED display. This graphic display is configurable by using the MENU system on your KILO or by using the BDX App. Complete range and ballistic information can now be simultaneously displayed as well as AMR and LOS range, angle of incline / decline, Density Altitude (DA), elevation / wind holds, bullet velocity and energy on target. Advanced features such as a digital compass and multiple reticles can now be user selected. There are 10 brightness settings including AUTO which uses an ambient light sensor to automatically adjust the display brightness for changing light conditions.

RANGING ACCURACY, RESOLUTION AND MAXIMUM RANGES

The KILO8K-ABS™ provides line of sight or angle modified range information accurate to ± 0.5 yards or meters out to 500 yards; ± 1 yard from 500 - 1000 yards and ± 2 yards beyond 1000 yards. Range is displayed in 0.1 yard or meter resolution.

RANGING PERFORMANCE IN HYPERSCAN MODE			
	Reflective	Trees	Deer
KILO8K-ABS™	Up to 8,000 yds	Up to 2,500 yds	Up to 2000 yds



GENERAL OPERATION

Download the BDX App from the Google Play Store or the Apple Store to install on your smartphone. Complete configuration instructions will be listed later in the manual on how to configure your BDX App on your smartphone. The instructions below provide general operation and configuration when using the rangefinder without the BDX App.

To turn the rangefinder ON, press and release either the RANGE or MODE buttons. To enter programming / configuration mode, press and hold down the MODE button from the ON state until the menu pops up in your field of view.

You will see the following menu:

- Range Mode
- Ballistic Profiles
- Wind Speed
- Wind Direction
- Target Mode
- Display Brightness
- Reticle Selection
- Unit of Measure
- Feature Settings
- Compass
- Onboard Sensors
- About
- Exit (Save)

Use the RANGE button to select a menu item and use the MODE button to index down the list. Once any selection is made you can use the MODE button to index down to Exit (Save) or press and hold the MODE button to exit / save and return to ranging.

RANGE MODE

Within the Range Mode submenu, you will have 4 options: BDX Elite, BDX External, Angle Modified Range and Line of Sight. BDX Elite is the default configuration and comes pre-loaded with 1 custom bullet profile based on a 0.308 bullet. BDX Elite utilizes the complete Applied Ballistics Elite calculator with the full AB bullet library and custom drag curves. BDX External can be used to connect to external devices such as the Kestrel 5700 and Garmin Foretrex. In BDX External mode, the LOS range and angle of incline / decline is sent to the external device where the ballistic solution is calculated, and then complete elevation and wind hold information is transmitted back to your KILO for display. For both BDX Elite and BDX External, the angle modified range will be displayed in the center of the display while the line of sight range will be displayed in the upper left of the display; the angle will be displayed in the upper right of the display.

AMR is the angle modified range or “rifleman’s rule” and provides the equivalent horizontal distance to the target. The AMR distance will be displayed in the center of the display below the reticle. LOS is the line of sight range to a target independent of angle. LOS will be displayed in the center of the display below the reticle and angle will be displayed in the upper right of the display.

You will see the following menu (BDX Elite is selected):

- BDX Elite
- BDX External
- AMR (Center Display)
- LOS (Center Display)
- Back (Save)



BALLISTICS PROFILE

Within the Ballistics Profile submenu, you will see all of your custom bullet profiles that have been created in the BDX App and synced with your KILO. The unit comes loaded with a .308 175 grain MatchKing bullet profile.

You will see the following menu (.308 175gr MK is selected):



WIND SPEED

Within the Wind Speed submenu, you will see a default value of a 5 mph crosswind. Use the MODE button to toggle down to +, - or Back (Save) and use the RANGE button to increase, decrease or save your desired value.

You will see the following menu:

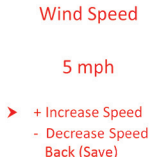

WIND DIRECTION

Within the Wind Direction submenu, you will see a clock with an arrow showing the direction the wind is coming from. Use the RANGE button to rotate the wind direction arrow to match your current wind conditions. Once your direction is set, use the MODE button to index to Back (Save) and press and release the RANGE button to save and exit back to the main menu.

You will see the following menu:

Wind Direction



- Rotate Clockwise
Back (Save)



TARGET MODE

Within the Target Mode submenu, you will see 5 options for selection. Last Target is selected by default. Last or Best Target Mode should be used in most situations. Last Target should be used for distant targets or targets located behind trees and foliage. Best Target provides the strongest return. First Target can be used when a target is in front of foliage and you want to be certain you are hitting the closest intended target. Extended Range can be used for targets at extreme distances. Your scan rate will drop from 4x per second to 1x per second with four times the sampling data being collected and analyzed to detect very remote targets; this mode can best be utilized when tripod mounted and will always return the last target detected. Fog mode can be used with fog or mist in the air and provides the last target detected.

All modes behave the same when attempting single button press ranges. However, when in SCAN mode, First and Last target behave differently. As you scan across multiple targets when in First Target mode, the closest range will be displayed and retained until a closer target is identified. Last Target does the opposite – targets that are progressively farther away will be displayed and persist until the RANGE button is released.

You will see the following menu:

- Last Target
- First Target
- Best Target
- Extended Range (XR)
- Fog
- Back (Save)

DISPLAY BRIGHTNESS

Within the Display Brightness submenu, you will see 10 options for selection. AUTO Adjust is default. You can select from 3 Low, 3 Medium and 3 High brightness settings. Auto adjust samples the ambient light conditions and adjusts automatically. Use the MODE button to index through the menu and the RANGE button to select.

You will see the following menu:

- AUTO Adjust
- High 3
- High 2
- High 1
- Medium 3
- Medium 2
- Medium 1
- Low 3
- Low 2
- Low 1
- Back (Save)



RETICLE SELECTION

Within the Reticle Selection submenu, you will see 5 options for selection. Circle is default. There are three options for the central aiming feature: a small circle, a duplex and a square box. You can also enable a horizontal or full milling grid as your reticle. If you select the grid option, your central aiming feature will be a circle.

You will see the following menu:

➤ Circle O
Duplex +
Square □
Grid OFF FULL HALF
Back (Save)

UNIT OF MEASURE

Within the Unit of Measure submenu, you will see 5 options for selection. English or metric are your primary choices. For holdover you can switch between MOA or MRAD (milliradians).

You will see the following menu:

Unit of Measure

➤ Distance	yards	meters
Wind	mph	m/s
DA	feet	meters
Milling Grid	MOA	MRAD
Holdover	MOA	MRAD
Temperature	F	C
Back (Save)		



FEATURE SETTINGS

Within the Feature Settings submenu, you will see 5 options for selection. This submenu allows you to completely disable Bluetooth, turn DA on or off during ranging (DA appears in the upper right hand corner of the display below the angle of incline), enable Battery Saver mode, turn off the startup splash screen or turn the Signal Meter on or off. The Signal Meter provides real-time feedback on the strength of the return signal – close ranges will show a full bar, remote targets will show a lower strength. All of these settings are accessible through the BDX App. Battery Saver mode doubles your battery life by limiting the maximum range to 2000 yards but will more than double the battery life of your KILO.

You will see the following menu:

Feature Settings

▶ Bluetooth:	<input type="checkbox"/> Enable	<input type="checkbox"/> Disable
DA:	<input type="checkbox"/> Enable	<input type="checkbox"/> Disable
Battery Saver:	<input type="checkbox"/> Enable	<input type="checkbox"/> Disable
Startup Screen:	<input type="checkbox"/> On	<input type="checkbox"/> Off
Signal Meter:	<input type="checkbox"/> On	<input type="checkbox"/> Off
Back (Save)		

COMPASS

Within the Compass submenu, you will see your compass heading or you will be asked to calibrate your compass. To calibrate your compass, while holding your rangefinder, sweep the unit through a figure 8 two to three times until your compass heading pops up. You can exit the compass by pressing and releasing RANGE or MODE buttons.

You will see the following menu:





ONBOARD SENSORS

Within the Onboard Sensors submenu, you will see the ambient temperature, pressure and humidity displayed from the sensors onboard your rangefinder. If your device is carried in a pocket, next to your body or in the sun, you may get an incorrect temperature reading. You can switch the temperature value stored in your rangefinder to MANUAL and then adjust the temperature. If you manually correct your temperature, it will be fixed at this value until changed manually or switched back to AUTO. You can also toggle between onboard, weather station or manual input within the BDX App.

You will see the following menu:

Onboard Sensors

Pressure: 29.8 in.
Humidity: 46.6%
Device Temp: 77 F

➤ Temp: Manual
Back (Save)

Onboard Sensors

Pressure: 29.8 in.
Humidity: 46.6%
Device Temp: 77 F

➤ Temp: AUTO
+ Increase Temp
- Decrease Temp 53° F
Back (Save)

ABOUT

Within the About submenu, you will see the current software versions installed on your KILO along with contact information for SIG SAUER and the serial number of your product.

You will see the following menu:

KILO8K About

FW Firmware Version: 13.060

FPGA Version: 39

Serial Number: K8K-12345

www.sigsauer.com

1-603-610-3000

➤ [Back \(Save\)](#)



HOTKEYS

You can quickly modify your wind speed and heading, or initiate QuickBOND by pressing and holding down the RANGE and MODE buttons simultaneously for 3 seconds. You will have two options: Set Wind Speed / Direction or initiate QuickBOND.

You will see the following menu:

- Set Wind Speed / Direction
- QuickBOND
- Back (Save)

THIS PAGE INTENTIONALLY LEFT BLANK



INSTALLING / USING THE BDX APP

The KILO was designed for long range shooters and hunters with onboard environmental sensors and an embedded ballistics calculator for greater precision at long distances. To get the most out of your rangefinder, download the SIG Ballistic App (SIG BDX) and synchronize your smartphone with your rangefinder. Once a ballistic profile is synchronized with your rangefinder you no longer need to carry your smartphone to take advantage of the advanced ballistics embedded on your rangefinder unless you intend to override environmental settings or anticipate needing real-time wind updates. By using the smartphone app simultaneously with the rangefinder you can see more information in real time by using the rangefinder screen in the app. Even better, you can actually range targets by using the RANGE button integrated on the rangefinder screen for remote operation.

In this section you will download the SIG Ballistic App (SIG BDX), set up a Ballistic Profile, configure your rangefinder by selecting one profile and then downloading one or more profiles to your rangefinder.

1. Download the BDX® App from the App Store / Google Play Store

Go to the App Store to download the SIG Ballistic App (SIG BDX) to an iOS based Apple product. For Android products go to the Google Play store. Search for SIG SAUER® or SIG Ballistic App (SIG BDX). Download and install the app on your smartphone.





2. Turn Bluetooth on and Pair

Once installed, launch the app – you will see the Home screen. You now need to sync your KILO with your smartphone. For iOS, all you need to do is ensure that Bluetooth is ON by going to Settings and sliding the toggle button until Bluetooth is ON. iOS devices automatically pair with your rangefinder from within the Sig Ballistic App. For Android you will need to formally pair the devices by going to Settings, then Bluetooth and sliding the toggle button ON. Make sure the rangefinder is nearby and also turned on by pressing and releasing the RANGE button. Your KILO should appear as a nearby device – select your rangefinder and you are now paired. Once you have formally paired your Android smartphone with your KILO, you will need to select the rangefinder from within the Home screen of the SIG Ballistic App. See images below.

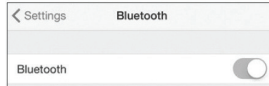
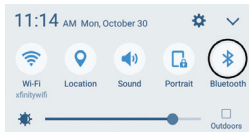
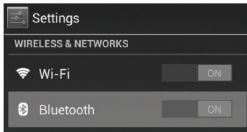

3. Launch the free SIG SAUER BDX® App and Pair with your KILO® (Enter your PIN code)

On your smartphone, open the BDX App, click on PAIRING, turn on your KILO by pressing and releasing the RANGE button. This will turn the Pair Rangefinder icon white. (Continued on next page)

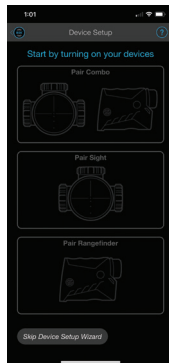
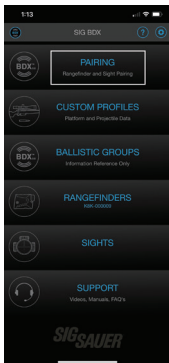



This will bring up the pairing screen. Tap the Pair Rangefinder icon. This will give you a list of rangefinders that are on and within range. Tap the rangefinder you wish to pair as identified by serial number. Look through your rangefinder and read the PIN. Type this PIN into the Pin Code Entry popup and tap OK. This will pair your rangefinder and the rangefinder icon will turn blue to indicate success. You may also pair a rangefinder by tapping Skip Device Setup Wizard on the opening screen and following the directions below. Instructions for pairing your wind meter are also below.

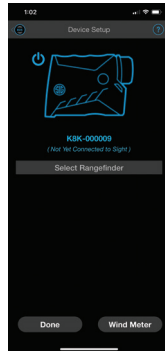
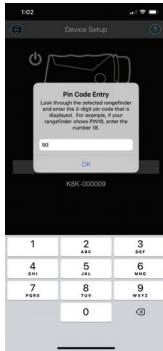
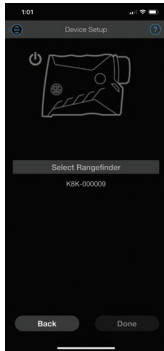
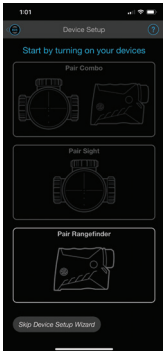

4. Pairing your WeatherFlow WINDMeter

Once your rangefinder is paired, you will be given the option to pair your WeatherFlow WindMeter. You can skip this step by pressing the SKIP button. If you choose to pair a wind meter, select your wind meter from the list on the screen. The wind meter will pair automatically. Once paired, the icon will turn blue.

Additional WEATHERMeter information:

Changing the battery: The WINDMeter takes a CR2450 battery. Remove the silicone “skin” to reveal a battery door. Slide the battery door open, replace the battery, and put the “skin” back on. The battery typically lasts 300-500 hours of use.

LED Indicator patterns: Slow flash (searching)
 Connected (none) Sampling (none) Shutting Down (fast flash)





5. Updating your KILO® to the latest software during Pairing

You may be prompted to update the software on your KILO. These software updates are mandatory and allow SIG SAUER to ensure that your BDX® App and KILO perform optimally. Most updates take less than 1 minute. Ensure that your KILO is turned on and that your smartphone has at least 25% battery life remaining before installing any software updates. For best operation be sure to keep your smartphone awake during the entire installation process.

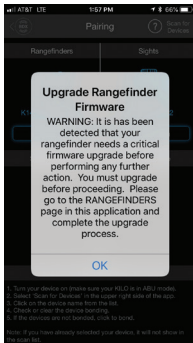
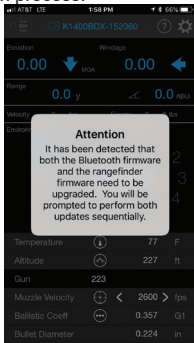

4. Configure up to 30 custom bullet profiles

The BDX App allows you to create and modify up to 30 profiles. From the home screen of the App touch **PROFILES**. Only one profile can be active at any time and is denoted by the BDX Icon in blue to the right of the screen. The BDX App comes with one default 0.308 profile. You can edit this profile by touching “Profile 1” or create a new one by touching the “New Profile” in the upper right corner of the App. You will be prompted to choose either a crossbow or a gun profile. If crossbow is selected, you will be taken to the crossbow profile editor. Tap each white number to change the values. You can rename your profile by tapping “NEW PROFILE” and typing a new name. Save your profile by tapping **SAVE** at the upper right.

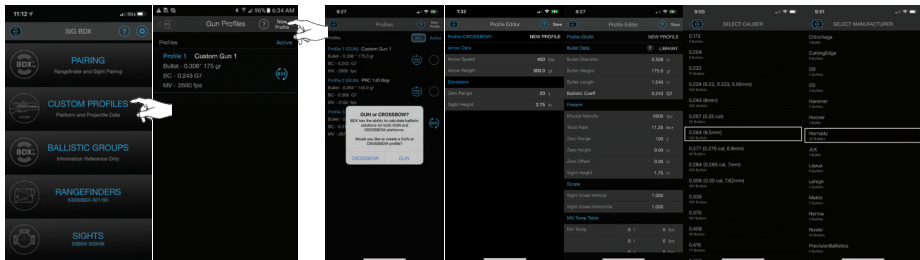



If “GUN” is selected, you will be taken to the Gun PROFILE EDITOR. In the PROFILE EDITOR. You can rename the profile by tapping “NEW PROFILE” and changing it, which will reflect elsewhere on the app and on your KILO. You may find your cartridge already in the “LIBRARY”. Select “LIBRARY” and you will be brought to a page with many common calibers listed. **(NOTE- This library is based on bullet diameter in the decimal scale, cartridges like 30-06 have a bullet diameter of .308 and can be found in the .308 section.)** After selecting your caliber, you will be brought to the bullet manufacturer menu. Find the correct manufacturer and corresponding bullet weight for your cartridge. After selecting your cartridge and manufacturer, you will be prompted to choose which drag curve to use: G1, G7 or Custom. If a Custom Drag curve is available, it is recommended that you select the Custom Drag curve since this bullet will have exact BC data for super, sub and transonic flight. **If you cannot find your cartridge in the library simply enter its characteristics manually on the main PROFILE EDITOR page. You can customize virtually any bullet characteristic that is in white (not greyed out). This is useful for those customers that hand load their ammunition or have characterized the rifle for such parameters such as muzzle velocity, sight height, bullet weight and zero Range.** Once your profile is created press “SAVE” in the upper right-hand corner of the screen. You can come back and adjust this information in your profile at any time.

Tapping the Sync button at the top of the page will copy all of your profiles onto your rangefinder. You can select which profile is active with the BDX button as stated above or by use of the menu in the rangefinder under Ballistic Profiles.

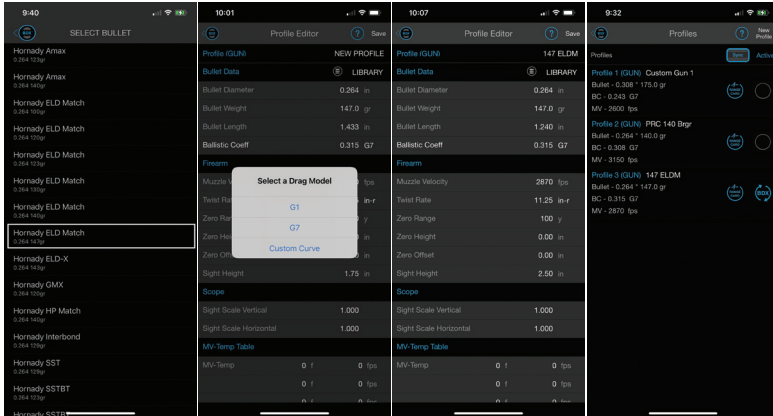



Tapping on the RANGE CARD icon will bring up the Targets card and range card for that profile. The first screen is the Targets card. The Targets card allows you to choose up to eight ranges for which to view the ballistics for the selected profile. The ranges are shown in blue. You can tap a range to change its value manually. You may also tap a range, then range a target and populate that value with the actual range to the target. At the top of the screen, you will find the Environmental Data. You may tap any value shown in white to change it. The ballistic data will update with each change. Tapping the arrow on the right will cycle through other parameters that may be changed for Wind, Heading, Inclination, and Latitude. You can tap right again to show the profile data.

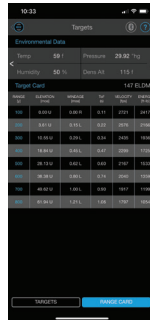
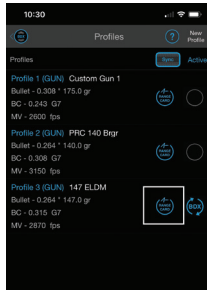

Tapping Range Card at the bottom of the screen will take you to the Range Card. The Environmental and other previously mentioned information will remain at the top of the screen. The Range Card shows the ballistic trajectory for the profile selected. The Range Card uses the units selected in the Rangefinder settings menu. Tapping on Range Card Settings pops up a menu allowing you to change the minimum and maximum distances as well as the distance increment. Tap on the value you wish to change and type in a new number. Tapping on Export Range Card pops up a window that allows you to enter an email address to which you would like to send a copy of your range card.

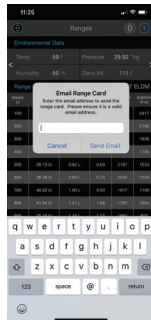
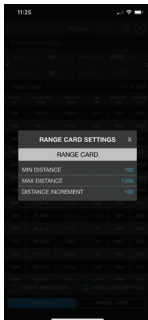
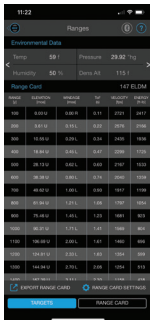



From the main menu, tap the gear icon in the upper right to access the global settings menu. From here you can customize your app and rangefinder by choosing in which units the following parameters are displayed.

Range units in yards or meters

Wind speed units in mph, m/s, or kph

Muzzle velocity units in fps or m/s

Bullet size units in inches or cm

Bullet weight units in grains or grams

Temperature units in F or C

Altitude units in feet or meters

Sight units in MOA or mrad

Gun parameters in inches or cm

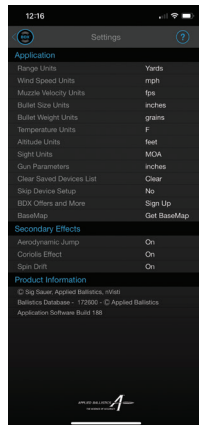
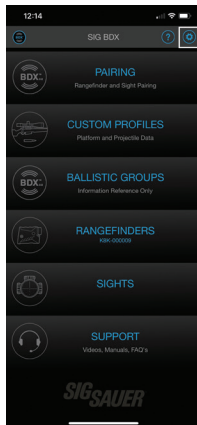

This is also where you can clear the devices that are paired with the app by tapping “Clear” next to Clear Saved Devices List.

You may also choose whether you want to skip the device setup by selecting “Yes” or “No” accordingly.

You also have to option to sign up for BDX offers or download the BaseMap app.

This is also the location for globally setting whether or not you want the secondary ballistic effects to be considered in the ballistic solver. These options include Aerodynamic Jump, Coriolis Effect, and Spin Drift.



Selecting Ballistic Groups from the main menu takes you to a list of eight ballistic groups that you may choose to select instead of setting up a unique profile. Follow the instructions for your optic (riflescope, etc.) to choose a ballistic group.

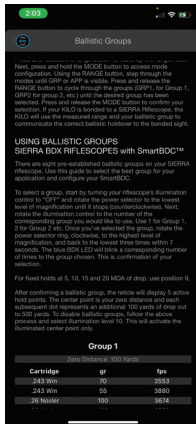
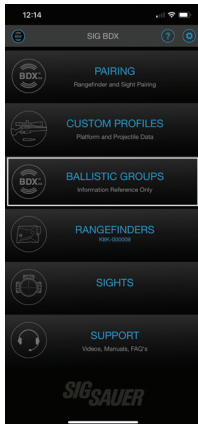

Tapping Rangefinders on the home page will bring up the rangefinder HUD. The top of the screen shows you your hold over, wind correction, range, and inclination. This is the same information displayed in your rangefinder. You can also see the velocity and energy left in your round at the target distance. In the middle of the screen you can adjust wind speed and direction manually. To adjust the speed, press on the + or – to increase or decrease the speed. To change direction, press on the number on the clock from which the wind is blowing.

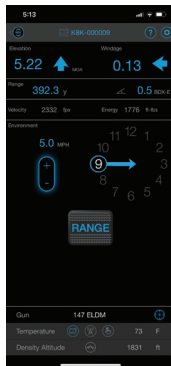
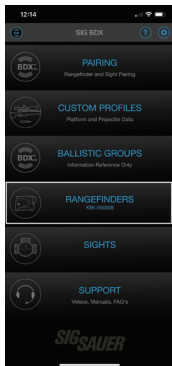



Below the wind adjustment, you will find a RANGE button. This will allow you to mount your rangefinder in a tripod and press this button to remotely trigger your rangefinder.

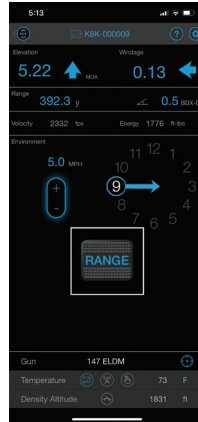
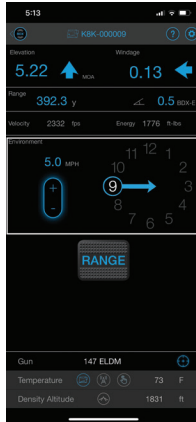
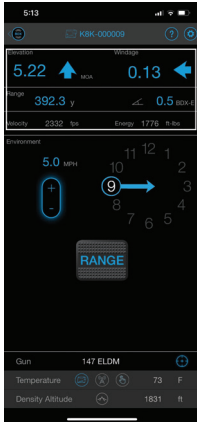

Pressing the profile name will take you to the profile page. From here you can select a different profile or create a new one. Pressing the Ballistic Calibration icon will give you a choice of two calibration routines. If you are shooting at ranges where your round is supersonic, use the Muzzle Velocity calibration. If you are shooting at ranges where your round will pass through transonic into subsonic, you should use the drop scale factor. If you are shooting subsonic ammo, such as 300 BLK, use the Muzzle Velocity calibration.

The ballistic calibration routines allow you correct for errors in your measured muzzle velocity. If you don't have a chronograph, you can input the stated muzzle velocity on your factory ammo box as a starting point. You will need to be able to shoot your rifle at distance while performing either calibration. The muzzle velocity option requires that you range and shoot at a single distance of at least 300 yards. The drop scale factor option requires that you range and shoot at two distances significantly further away. The exact distances will vary depending on the caliber and projectile you are shooting as the distances required are in the transonic and subsonic regions for your specific combination. Suggested ranges are provided on the calibration screen.

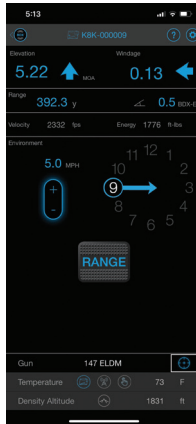
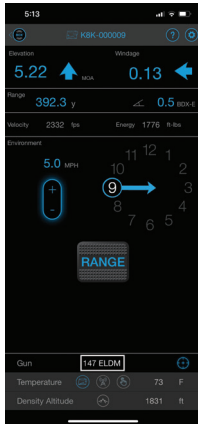

In order to use the Muzzle Velocity Calibration, you need to range a target at a range of at least 300 yards. In this example, the target is at 392.7 yards. Using the ballistic solution provided by the app for your profile, shoot a 3-5 shot group into that target. Measure the distance from your point of aim to the center of the group. Now open the app and go to the rangefinder HUD screen. Range the target again. Then press the Ballistic Calibration icon. You will get a popup asking which calibration type you would like to perform. Tap Muzzle Velocity. In this example, the center of the group was high. Next, you will be asked which units you measured in. In the example, the units are inches. Then you will be asked how many units you measured. In this example, the distance was 2 inches. Tap Confirm to accept the calibrated muzzle velocity. Range the target again and notice the new hold over value based on the updated muzzle velocity.

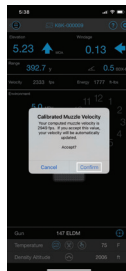
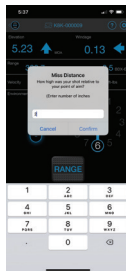
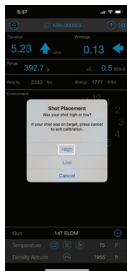



Selecting Drop Scale Factor brings you to the advanced muzzle velocity and drop scale factor screen. Notice in this example of a 6.5 PRC, the suggested distances are significantly further than 300 yards. Here, you will input the two ranges that you are shooting and the total drop at each range. Press the calculate button. Your new muzzle velocity and drop scale factor will populate in the results section. Press Set MV and Set DSF to accept the new values.

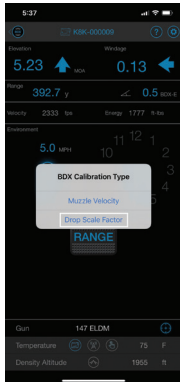

Towards the bottom on the screen you will find the environmental parameters. For temperature, there are three choices for where the value is derived. Tap any of the three icons to choose it and turn it blue. The first icon indicates that the temperature will be taken from the rangefinder's onboard sensors. The second icon indicates that the temperature will be taken from the closest local weather station. The third icon allows you to manually input the temperature. Tapping that icon will turn the numerical value from gray to white. You may then tap the number and change it.

Density altitude is calculated from the onboard sensors for pressure and humidity and whichever temperature solution you have selected. The value for density altitude is reported to the right.

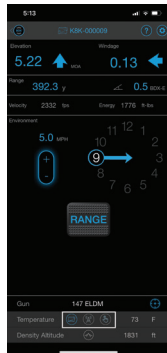



In the upper right of the screen, you will find the gear icon for the rangefinder settings. From here you can customize your app and rangefinder by choosing in which units the following parameters are displayed. These parameters may also be set within the rangefinder menu on the device itself as described earlier. Tap the values in white to change them.



Tapping on Show Dimensions will bring up the Reticle Dimension screen. Tap the Blue words to cycle through the various center reticles, grid patterns, and units of measure. The gray numbers give the dimensions of the respective feature.

Tapping Alignment Mode will bring you to the reticle alignment screen. Here, you will be provided the ability to adjust the aiming reticle by up to 5 pixels in any direction. Some professional / expert users will sometimes find that the actual laser bar is slightly decentered from the exact center of the aiming circle (duplex or box) and may want to make a minor correction to the aiming feature. You must do this in conjunction with your rangefinder and your rangefinder should be tripod mounted. Pressing the U,D,L,R buttons will move your reticle up, down, left, or right accordingly. How far your reticle has moved is shown in the middle of the screen. The range to your target is also displayed.

This functionality will allow you to range a very precise target and test that your laser is properly centered in the aiming feature.

You will need to remotely range with the BDX App and make minor adjustments to your KILO to make sure that you are getting accurate ranges from a very small target. Most users find that the top of a telephone pole or antenna works best with only the sky behind the target, so you can know with precision that you are in fact ranging your target. Once you confirm that the rangefinder is returning the correct range for this small target, use the U,D,L,R buttons while looking through the rangefinder to adjust the center position of the reticle to the center of the target.

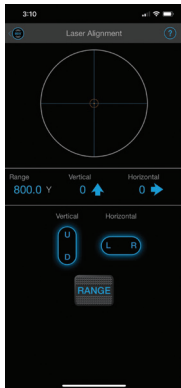
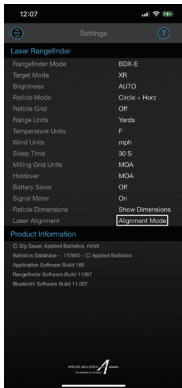
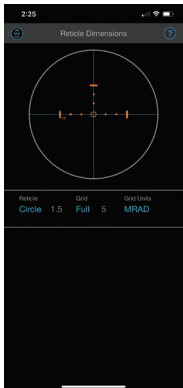
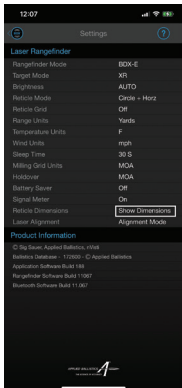
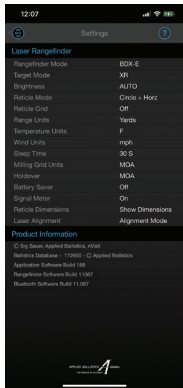

BASEMAP™

To connect your KILO to your BaseMap app, first, open BaseMap. Tap on Tools in the lower right. Tap on BaseMap Connect in the upper right. Turn on Bluetooth, if needed, and tap on your rangefinder in the available devices menu. Read the PIN in your rangefinder display and enter it in the BaseMap popup. Select OK. Your rangefinder is now paired with BaseMap. Use the Remote Marker option from the tools menu to range targets and automatically drop markers on your map at that location.

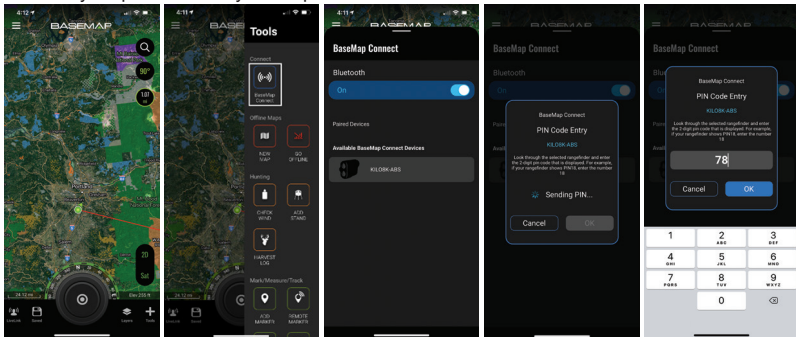



FREQUENTLY ASKED QUESTIONS (FAQ)

Q: I am pressing the RANGE button and nothing happens?

A: Check to make sure you have a fresh CR2 battery installed. If the battery is new, try loosening and tightening the battery cap until the cap is snug. If this doesn't fix the problem you may have switched the rangefinder into one of the low brightness settings for the OLED display. Go into a dark room and press the RANGE button. In this case, if the display becomes barely visible you need to go into programming mode and adjust the brightness to a medium or high setting, or put the display in AUTO adjust mode.

Q: Information on the display is disappearing – is this normal?

A: Yes. The rangefinder OLED display was optimized to only present the most important information while in use. Upon initial wake up, all your settings are visible such as the battery indicator, Line of Sight (LOS) or Angle Modified Range (AMR), LAST or BEST target mode and unit of measure. After the first range is acquired or in SCAN mode, after about 2 seconds, only the aiming circle and range information is displayed.

Q: I can't get the display to focus?

A: You need to adjust the diopter ring to your vision. The diopter ring is located in front of the eyecup and rotates approximately 40 degrees in either direction to accommodate your unique prescription.

Q: I can't seem to range past 1200 yards on trees?

A: The rangefinder will have very different performance based on changes in ambient conditions such as bright sunlight or snow, rain or fog, temperature and the reflectivity of the target being ranged. For example, at dusk or dawn your rangefinder may be able to range trees at over 2000 yards but in bright sunlight may only achieve 1100 yards. This is normal, however, the KILO is the highest performance compact rangefinder available.

Q: My battery seems to drain too fast?

A: Most commercial rangefinders will provide over 4000 individual range calculations using a fresh CR2 primary lithium battery. The KILO has additional sensors and Bluetooth which consume more battery power. The rangefinder exceeds 4000 ranges on a fresh battery, however, when heavily using SCAN mode this will cause the battery to drain much faster as the range processor remains active at all times and you will quickly exceed 4000 range calculations due to the HyperScan mode. This is normal operation but you should always keep a spare CR2 battery when heading out to remote locations. You can also turn off Bluetooth to extend your runtime.

Q: When in SCAN mode my rangefinder turns off after 20 seconds, is this normal?

A: Yes - the SCAN mode is limited to 20 seconds to remain eye safe in all conditions. You can reenter SCAN mode by releasing and pressing the RANGE button again.



Q: My Bluetooth link between my smartphone and my rangefinder keeps disconnecting?

A: You can update your Settings / Preferences from the home screen on your app. Click on the Settings / Preferences button in the upper right hand corner of the screen and then change the KILO Timeout setting to 30, 60 or 180 seconds. This will keep the rangefinder awake longer allowing you to synchronize and update settings. However, by increasing the KILO Timeout settings this will also force you to wait longer to put the rangefinder back into Programming Mode. You will have to wait for the rangefinder to timeout, wake the unit back up by pressing the RANGE button and then pressing and holding down the MODE button for 2 seconds to re-enter programming mode. Or, alternatively, you can close the SIG Ballistic App and then enter programming mode if you don't want to wait for the rangefinder to time out. If you are still experiencing connection issues make sure you are using the latest version of the SIG Ballistic App. You can update your app from the App Store or the Google Play store. You may also need to turn your Bluetooth radio OFF and back ON again to restore the link.

Q: I'm getting a different temperature reading from my rangefinder when I know the ambient temperature is different?

A: If you are carrying the rangefinder in a pocket or it is sitting in the sun it may sense a different temperature than the ambient environment. You can either let your rangefinder sit in the shade for a few minutes or you can override the temperature by entering the Environment sub menu on the app, touching the KILO icon next to the word "TEMPERATURE" and manually entering the temperature – be sure to press SYNC to update the temperature on the rangefinder.

Q: My rangefinder is not calculating elevation and wind holds – no holds are showing up on the OLED display or in the HUD on the app?

A: Your rangefinder is probably set to AMR (Angle Modified Range). In AMR mode only the angle modified range is displayed on the HUD and on the OLED display. Go into Programming Mode and switch the range mode from AMR to LOS. Next, select a Profile (i.e. Pro 1). Be sure to have at least one Profile configured on your app and synchronized with your rangefinder.

Q: My rangefinder is not working. I've tried everything but the display will not turn on.

A: It is possible that you have set the display brightness to setting LOW 1. Go into a dark room and press the RANGE button. You should see the display. Press and hold the MODE button down to enter the programming mode. Press and release the MODE button until you see the display setting (i.e. Low 1). Press the RANGE button to select a different setting such as Hi 1 or AUTO. AUTO is recommended as the display will now automatically adjust to the correct brightness based on your local conditions. Once selected continue pressing the MODE button until you exit the programming mode.

Q: My blue LED on the power selector ring on my SIERRA3 will not turn on.

A: Look through your SIERRA3. You most likely have the Digital Ballistic Reticle turned ON. Go into your BDX App, select the SIGHTS page and turn the Ballistic Reticle OFF.



Q: My ballistic solution in the HUD and displayed in the KILO is always off a few inches.

A: For accurate ballistic solutions make sure you have updated the temperature and altitude within the App to your current location, you have the correct bullet caliber (diameter) and weight selected, your zero distance is correct and that your muzzle velocity is correct. Using the MV Calibration routine provides the most accurate MV and will improve the accuracy of the ballistic calculator. It is always best to use the MV Calibration routine at the farthest distance you intend to shoot. Calibrating at 500 yards will yield a better MV than calibrating at 300 yards.

Q: When using AB External on my KILO I can no longer see the rangefinder information on the HUD in the BDX App.

A: If your KILO and a Kestrel are actively paired (sending / receiving information) the BDX App cannot be connected and paired to your KILO at the same time.

Q: My KILO is set to AB External but isn't displaying holdover information.

A: To display a complete ballistic solution your KILO must be actively paired with a Kestrel. No holdover information is displayed unless the Kestrel and KILO are both on and actively paired.

Q: The rangefinder HUD in the BDX App is sluggish when using my KILO in AB External mode (Kestrel is not paired to the KILO).

A: AB External mode on your KILO was designed to be used directly with a Kestrel with AB Elite on board. This communications protocol is relatively slow and does not respond quickly as compared to using AB Ultralight. AB Ultralight resides on your KILO and is much faster for calculating ballistic solutions out to 800 yards.

Q: My KILO and Kestrel are paired but I am not getting anything but zero's for elevation and wind holds.

A: You need to setup at least one custom bullet profile on your Kestrel. See the Kestrel instructions for setting up a bullet profile.

**KILO8K-ABS™ 7x25 mm SPECIFICATIONS**

Magnification	7x		
Objective Clear Aperture	25 mm		
Exit Pupil	3.6 mm		
Eye Relief	16 mm		
Angular (FOV)	6.78°		
FOV @ 100yds	35.67 ft		
Laser Divergence	1.25 x 0.25 MRAD		
Range Response Time	.25 sec		
Scanning	Yes		
Range Resolution Under 100 yds	.1 yds		
Max Range	Reflective Up to 8,000 yds	Trees Up to 2,500 yds	Deer Up to 2000 yds
Weight with Battery	7.5 oz / 215 g		

A – 3 in / 76 mm
B – 4.4 in / 112 mm
C – 1.3 in / 33 mm

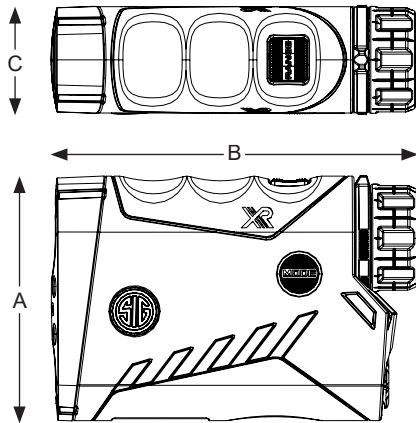



WARNING LASER



CLASS 3R LASER PRODUCT INVISIBLE LASER RADIATION - AVOID DIRECT EYE EXPOSURE

This product complies with IEC 60825-1: 2014-05 Ed 3.0 and complies with FDA performance standards for laser products except for deviations pursuant to Laser Notice No. 50, dated June 24, 2007.

3R: FCC: 2AP8SK24 IC: 24032 -K24
 $P_o < 20W, \lambda = 905 \text{ nm}, t = 22 \text{ ns}$



This product has been tested and found to comply with the limits for a Class B digital device, pursuant to Part 15 of the FCC Rules. The equipment generates, uses and can radiate radio frequency energy and, if not installed and used in accordance with these instructions, may cause harmful interference to radio communications. However, there is no guarantee that interference will not occur in a particular installation. If this product does cause interference to radio or television reception the user is encouraged to try to correct the interference by one or more of the following:

- Reorient or relocate the receiving antenna
- Increase the separation between this product and the receiver

- Connect the equipment to an alternative outlet or receiver
- Consult a technician.

Shielded interference cable must be used with the equipment in order to comply with the limits for a digital device pursuant to Subpart B of Part 15 of FCC Rules.

Specifications and designs are subject to change without any notice or obligation on the part of the manufacturer.

CAUTION

Use of controls or adjustments or performance of procedures other than those specified herein may result in hazardous radiation exposure. Changes or modifications not expressly approved by the party responsible for compliance could void the user's authority to operate the equipment.



LASER APERTURE



FCC STATEMENT:

This device complies with Part 15 of the FCC rules. Operation is subject to the following two conditions:

- This device may not cause harmful interference, and
- This device must accept any interference received, including interference that may cause undesired operation.

Changes or modifications not expressly approved by the party responsible for compliance could void your authority to operate the equipment.

NOTE

This equipment has been tested and found to comply with the limits for a Class B digital device, pursuant to Part 15 of the FCC Rules. These limits are designed to provide reasonable protection against harmful interference in a residential installation.

This equipment generates uses and can radiate radio frequency energy and, if not installed and used in accordance with the instructions, may cause harmful interference to radio communications. However, there is no guarantee that interference will not occur in a particular installation. If this equipment does cause harmful interference to radio or television reception, which can be determined by turning the equipment off and on, the user is encouraged to try to correct the interference by one or more of the following measures:

- Reorient or relocate the receiving antenna.
- Increase the separation between the equipment and receiver.
- Connect the equipment into an outlet on a circuit different from that to which the receiver is connected.
- Consult the dealer or an experienced radio/TV technician for help.



INDUSTRY CANADA:

This device complies with Industry Canada licence RSS standard(s). Operation is subject to the following two conditions:

- This device may not cause interference, and
- This device must accept any interference, including interference that may cause undesired operation of the device.

Le présent appareil est conforme aux CNR d'Industrie Canada applicable aux appareils radio exempts de licence.

L'exploitation est autorisée aux deux conditions suivantes:

- l'appareil ne doit pas produire de brouillage, et
- l'utilisateur de l'appareil doit accepter tout brouillage radio électrique subi, même si le brouillage est susceptible d'en compromettre le fonctionnement

The device meets the exemption from the routine evaluation limits in section 2.5 of RSS 102 and compliance with RSS-102 RF exposure, users can obtain Canadian information on RF exposure and compliance.



WARNING: CANCER AND REPRODUCTIVE HARM—www.P65warnings.ca.gov



SIG SAUER ELECTRO-OPTICS INFINITE GUARANTEE[®] / LIMITED LIFETIME WARRANTY

SIG SAUER[®] has manufactured the most rugged, dependable, high-performance firearms for more than two centuries. Our heritage of design, engineering, and precision-manufactured quality predates the existence of any other optics company worldwide. We understand the importance of quality in the line of fire, at the shooting range or on your next hunt. SIG SAUER Electro-Optics had to earn the right to wear that badge and the Infinite Guarantee has your back, forever. Period.

We will repair or replace your SIG SAUER product in the event it becomes damaged or defective, at no charge to you. If we cannot repair your product, we will replace it with a product in perfect working order of equal or better physical condition.

SIG SAUER[®] Infinite Guarantee[®]

- Unlimited Lifetime Guarantee
- Fully Transferable
- No Warranty Card Required
- No Receipt Required
- No Time Limit Applies
- No Charge

Please note that our Infinite Guarantee excludes coverage for intentional damage, misuse, cosmetic damage that does not affect the performance of the optic, loss, theft, or unauthorized repair or modification. Excludes electronic and Tritium components.

Customers seeking warranty coverage must first obtain a Return Merchandise Authorization (RMA) by contacting SIG SAUER Customer Service, and return the product unloaded and freight prepaid.

ANY WARRANTIES IMPLIED BY LAW, INCLUDING ANY IMPLIED WARRANTIES OF MERCHANTABILITY OR FITNESS FOR A PARTICULAR PURPOSE, ARE EXPRESSLY DISCLAIMED. REPAIR, ALTERATION, OR REPLACEMENT AS PROVIDED HEREIN IS YOUR EXCLUSIVE REMEDY FOR ANY DEFECTIVE PRODUCT. IN NO EVENT SHALL SIG SAUER OR ANY COMPANY AFFILIATED WITH SIG SAUER BE LIABLE FOR ANY SPECIAL, INCIDENTAL, OR CONSEQUENTIAL DAMAGES OF ANY KIND ARISING OUT OF THE PURCHASE OR USE OF THIS PRODUCT, WHETHER BASED UPON CONTRACT, TORT, STATUTE, OR OTHERWISE. Some states do not allow the exclusion or limitation of implied warranties, or the exclusion or limitation of incidental or consequential damages, so some or all of the above limitations or exclusions may not apply to you. This warranty gives you specific legal rights, and you may also have other rights which vary from State to State.

THIS WARRANTY APPLIES TO COMMERCIAL CUSTOMERS ONLY, AND DOES NOT APPLY TO GOVERNMENT, MILITARY, LAW ENFORCEMENT, OR NON-US CUSTOMERS. NON-US COMMERCIAL CUSTOMERS MUST PURCHASE PRODUCT THROUGH AN AUTHORIZED SIG SAUER DEALER WITHIN THEIR COUNTRY OF RESIDENCE FOR THIS WARRANTY TO APPLY.



SIG SAUER® ELECTRONIC COMPONENT LIMITED 5-YEAR WARRANTY



SIG SAUER warrants that the electronic and tritium components of the enclosed product were originally manufactured free of defects in workmanship, material, and mechanical function. For a period of five (5) years from the date of manufacture, SIG SAUER agrees to correct any defect in these components by repair, adjustment, or replacement, at SIG SAUER's option, with the same or comparable quality components (or by replacing the product at SIG SAUER's option); provided however that a Return Merchandise Authorization (RMA) is first obtained by contacting SIG SAUER Customer Service, and that the product is returned unloaded and freight prepaid.

This limited warranty is null and void if the product has been misused, damaged (by accident or otherwise), damaged through failure to provide reasonable and necessary maintenance as described in the user's manual, or if unauthorized repair or any alteration, including of a cosmetic nature, has been performed on the product. This limited warranty does not apply to normal cosmetic wear and tear of any parts.

ANY WARRANTIES IMPLIED BY LAW, INCLUDING ANY IMPLIED WARRANTIES OF MERCHANTABILITY OR FITNESS FOR A PARTICULAR PURPOSE, ARE EXPRESSLY DISCLAIMED. REPAIR, ALTERATION, OR REPLACEMENT AS PROVIDED HEREIN IS YOUR EXCLUSIVE REMEDY FOR ANY DEFECTIVE PRODUCT. IN NO EVENT SHALL SIG SAUER OR ANY COMPANY AFFILIATED WITH SIG SAUER BE LIABLE FOR ANY SPECIAL, INCIDENTAL, OR CONSEQUENTIAL DAMAGES OF ANY KIND ARISING OUT OF THE PURCHASE OR USE OF THIS PRODUCT, WHETHER BASED UPON CONTRACT, TORT, STATUTE, OR OTHERWISE.

Some states do not allow the exclusion or limitation of implied warranties, or the exclusion or limitation of incidental or consequential damages, so some or all of the above limitations or exclusions may not apply to you. This warranty gives you specific legal rights, and you may also have other rights which vary from State to State.

THIS WARRANTY APPLIES TO COMMERCIAL CUSTOMERS ONLY, AND DOES NOT APPLY TO GOVERNMENT, MILITARY, LAW ENFORCEMENT, OR NON-US CUSTOMERS. NON-US COMMERCIAL CUSTOMERS MUST PURCHASE PRODUCT THROUGH AN AUTHORIZED SIG SAUER DEALER WITHIN THEIR COUNTRY OF RESIDENCE FOR THIS WARRANTY TO APPLY.



NOTES:

NOTE:

SIG SAUER®

[sigsauer.com](https://www.sigsauer.com)

FOR PRODUCT SERVICE ON THIS MODEL, PLEASE CALL 603-610-3000

27100 SW Parkway Avenue, Wilsonville, Oregon 97070 USA